

Guide to Low Voltage System Design and Selectivity

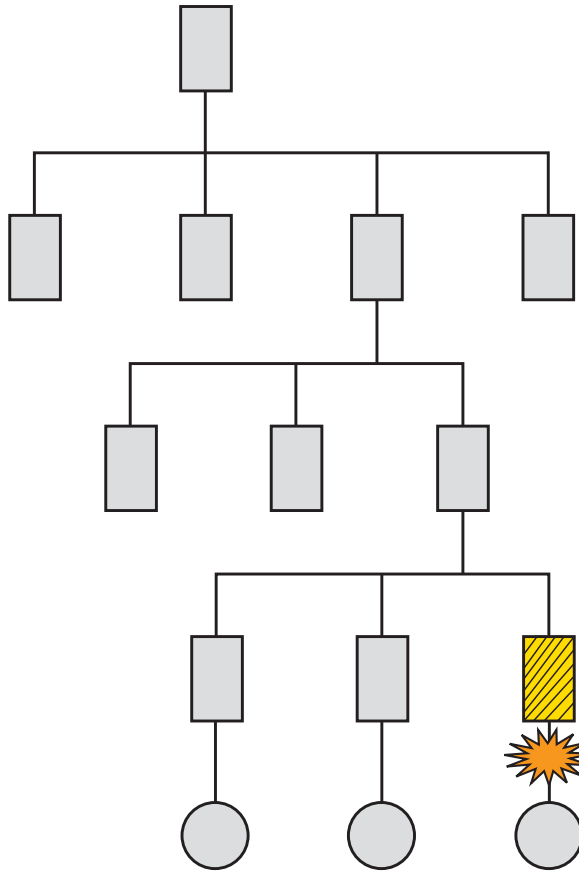

□ Unaffected ▨ Opens



imagination at work

Contents

Foreword	1
Introduction	2
National Electric Code Requirements	3
Selective System Design Considerations	
Ground Fault Protection	4
MCCB Layer Limitations - Riser / Feed Through Lug Panels	5
Automatic Transfer Switch (ATS) Protection	7
Switchboard Protection	7
Transformer / Current Limiting Reactor Applications	7
Design Tips Summary	7
Selectivity for Existing Systems	8
Arc Flash Considerations	8
Selective Low Voltage Circuit Breaker Pairings Diagram	9
Popular GE Selective Circuit Breaker Pairings - Summary Table	
GE Circuit Breaker / Equipment Combinations	10
Appendix	
Selective Time Current Curve Templates	13
15 kVA with FB Primary & TEY Secondary Mains	14
30 kVA with FB Primary & TEY Secondary Mains	16
30 kVA with FG Primary & FG Secondary Mains	18
45 kVA with FG Primary & FG Secondary Mains	20
75 kVA with FG Primary & FG Secondary Mains	22
112.5 kVA with FG Primary & FG Secondary Mains	24
112.5 kVA with FG Primary & S7 Secondary Mains	26
150 kVA with FG Primary & FG Secondary Mains	28
150 kVA with S7 Primary & S7 Secondary Mains	30
225 kVA with FG Primary & S7 Secondary Mains	32
300 kVA with S7 Primary & S7 Secondary Mains	34
Typical GE Dry Type, 480 - 120/208V Transformer Impedances	36
Glossary	37

Information provided herein may be subject to change without notice. Products in this publication are designed and manufactured in accordance with applicable industry standards. Proper application and use of these products is the responsibility of GE's customers or their agents in accordance with the standards to which they were built. GE makes no warranty or guarantee, expressed or implied, beyond those offered in our standard Terms and Conditions, in effect at the time of sale. Any questions about the information provided in this document should be referred to GE.

Foreword

GE's first application publication on instantaneous selectivity, GE Overcurrent Instantaneous Selectivity Tables (DET-537, available in the Publications Library at www.geelectrical.com) lists GE low voltage circuit breakers and the short circuit current to which they are selective. Since that was published, product innovation, rigorous selectivity testing and real-world experience with selectivity requirements have improved GE's selectivity solutions.

The 2008 National Electric Code® (NEC) included some refinement and additions to the originally published "Coordination" requirements for selectivity. While there is still no uniform interpretation of these requirements, many Authorities Having Jurisdiction (AHJs) in the United States are enforcing instantaneous selectivity requirements for "Emergency" and "Required and Standby" systems. It can be expected that, once an AHJ has accepted these requirements, they will accept later versions of the NEC articles, including NEC Article 708 – Critical Operations Power Systems.

Following the introduction of coordination requirements in Articles 700 and 701 in the 2005 edition of the NEC, "caution" was the operative word as users, designers and suppliers adjusted their traditional design and procurement patterns to meet the new NEC selectivity requirements. Because the regulations are interpreted differently by different AHJs, all involved responded to a variety of interpreted requirements. Today, GE will confidently provide design assistance and selective solution quotations for the majority of customer applications, regardless of the local AHJ interpretations.

This publication does not replace our original selectivity publication, but provides supplemental information for those involved in the layout, design and quotation processes. The data in DET-537 continues to be the most comprehensive representation of selective circuit breaker pairings that GE offers. In this publication, we convey the essentials of selective system applications in a more easily used context. When using DET-537, make sure you are using the latest version available. The most current version can be found on GE's website.

Introduction

What is selectivity?

The electrical design industry has historically required electrical system circuit breaker selections and settings be validated with a short circuit and coordination study performed by a licensed engineer. These studies assure that circuit breakers are capable of interrupting the available current and would operate "selectively." Traditionally, "selectivity" in a low voltage electrical system meant that the long time and short time portions of time-current curves (TCCs) would be selective, i.e. the circuit breaker closest to the fault would trip first, maximizing the amount of the electrical distribution system left in service. In most cases, the circuit breaker instantaneous overcurrent (IOC) TCCs would not be selective "on paper," as they typically overlap.

In Figure 1A, there is no "instantaneous selectivity" apparent on the TCC, as the instantaneous portion (below 0.1 seconds) of the curves show all three breaker characteristics overlapping. The long time and short time characteristics (above 0.1 seconds) do not overlap and are therefore selective. In Figure 1B, the 1600 amp AKR and Spectra F200 circuit breakers are selective, as the instantaneous function of the AKR is not used, so there is no overlap of these two characteristics.

Traditionally, selectivity between molded case circuit breakers (MCCBs) and insulated case circuit breakers (ICCBs) was considered effective, even if there was an overlap of TCCs in the instantaneous region. The most prevalent type of fault, the line to ground arcing fault, often limits the fault current magnitude enough that the upstream circuit breaker IOC function does not operate. If the fault is removed promptly, the likelihood of it escalating into a multi-phase, bolted type fault is very low. As a result, for a large majority of faults, the traditional long time, short time selectivity has been sufficient to produce selective operation of circuit breakers.

The 2005 and 2008 NEC extend the selectivity requirement to all possible fault types and magnitudes for certain critical electrical circuits, i.e., those typically fed from automatic transfer switches (ATS). These circuits and requirements are those discussed in the following NEC articles:

- Article 700: Emergency Systems (Legally Required), 700.28 Coordination
- Article 701: Legally Required Standby Systems, 701.17 Coordination
- Article 708: Critical Operations Power Systems, 708.54 Coordination

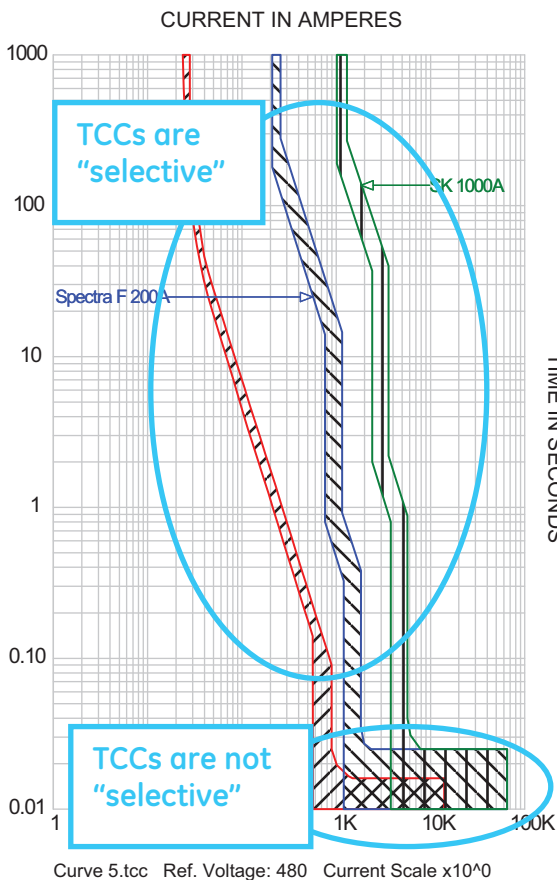

Figure 1A

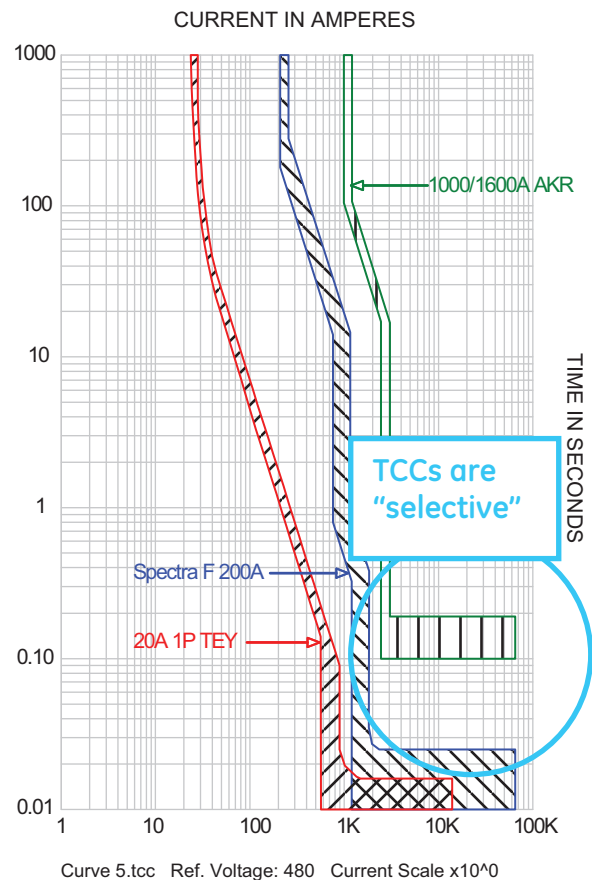

Figure 1B

These requirements state that overcurrent protective devices (OCPD) must be “fully selective.” In other words, given the range of available interrupting currents, any given pair of overcurrent devices covered by the NEC Articles referenced above must behave in a coordinated fashion as defined in NEC Article 100:

“Coordination (Selective). Localization of an overcurrent condition to restrict outages to the circuit or equipment affected, accomplished by the choice of overcurrent protective devices and their ratings or settings.”

The NEC requirements are desirable design goals, given the adverse consequences of larger than necessary power outages within critical circuits. However, there are other design considerations that these requirements seem to preclude, i.e., arc flash and the specifics of phase and ground fault overcurrent coordination. The ability of fully selective designs to provide sufficient protection to such important, sensitive equipment as generators or automatic transfer switches may be affected.

This publication uses the information on instantaneously selective breaker pairings contained in DET-537 as a base, and goes on to discuss specific tactics for developing fully selective electrical distribution designs. Though instantaneous selectivity is possible in many cases, it is not always easily accomplished with the considerations mentioned above. It has long been the responsibility of the licensed engineer of record to assess all performance requirements and produce a balanced, practical design.

National Electric Code (NEC) Requirements

The 2008 NEC Articles 700.27, 701.18 and 708.54 requirements for Coordination say:

“... overcurrent devices shall be selectively coordinated with all supply side overcurrent protective devices.”

This wording does not exempt ground fault protection from selectivity, nor does it exempt selectivity with the normal side supply sources. Even though this requirement is found in the Special Conditions chapter of the NEC dealing with Emergency Systems, Legally Required Systems and Critical Operations Power Systems (COPS), it states the emergency overcurrent protective devices must be selectively coordinated with *all* supply side overcurrent protective devices. This terminology implies that selectivity with both normal and emergency supply sources is required for both phase and ground fault OCPDs. **(Note: The local AHJ has the final word on interpretation of the NEC and other applicable code language. It is important to use their interpretation when designing and quoting selective systems.)** Full selective coordination in systems with ground fault protection can be difficult and is beyond the intended scope of this publication.

To date, a large variety of interpretations of the NEC requirements have been made. Numerous state and local AHJs have excluded these “Coordination” requirements from their enforcement codes, or have modified them. At the time this publication was written, the most mentioned alternative to the NEC “full selectivity” requirements is the “0.1 second rule.” This definition of selectivity has been adopted by some AHJs, including, most notably, Florida’s Agency for Health Care Administration (AHCA). This selectivity requirement preceded the 2005 NEC requirements by decades.

The AHCA requirements are broader than those in the NEC as they apply to the entire facility, not just critical circuits. Therefore, faults on non-critical portions of the system will not result in an unwanted shutdown of critical circuits because of non-selective breaker operations. This standard is often criticized because it only requires selectivity down to 0.1 seconds. However, it represents the long-standing design practices employed by electrical systems designers. The AHCA requirements, which allow the overlap of OCPD IOC functions, result in reduced clearing times and associated arc flash hazards and require selective coordination for the entire facility.

The AHCA 0.1 second allowance does have sound engineering basis. It is probable that most system faults are line to ground arcing faults on branch circuits. These faults will probably fall beneath the IOC threshold of the larger circuit breakers above the branch circuit breaker nearest the fault. Ground faults in parts of a system with high short circuit currents may be quite high in magnitude. Sensitive ground fault protection is often sufficient to sense and clear arcing ground faults well below IOC levels of upstream devices. Two levels of selective ground fault protection have been required in certain hospital systems by NEC Article 517 for many years.

It is important to note that “full selectivity” is often facilitated by increasing trip time delays and increasing pickup thresholds in upper tier OCPDs. Allowing instantaneous protection to be applied throughout the system improves protection and decreases arc flash hazard. The impact of designing for full selectivity in systems that require “live work” should be studied and understood so optimized design decisions can be made and hazards identified.

The first words of NEC, Article 90.1, Purpose, are: “**(A) Practical Safeguarding**. The purpose of this *Code* is the practical safeguarding of persons and property from hazards arising from the use of electricity.” Historically, the NEC started by establishing protection requirements for low voltage loads, cables, transformers, etc. This has always been and continues to be the Code’s first priority. While Articles requiring “fully selective” systems are consistent with the “Practical Safeguarding” requirements, these Articles do not take precedence over competing protection and design needs.

In the absence of specific language in NEC Articles 700, 701 and 708 for coordination, interpretations of the NEC code vary significantly. Some interpretations require full selectivity through the critical circuits, to both the normal and emergency supplies. Others require critical circuit breakers to be selective to the automatic transfer switch (ATS) using the normal supply short circuit current, then continue the selectivity only to the emergency supply above the ATS using the emergency source short circuit current. A third popular interpretation requires selectivity through critical circuits to the emergency supply only. (Please note that the short circuit current from the emergency source is often much less in magnitude than the normal supply.) Where this is the case, designers have more selective breaker pair choices and the potential ability to reduce the size and cost of a selective system solution.

Some AHJ’s and the State of Massachusetts require selectivity of critical circuits to be addressed, but leaves the extent of the requirement to the discretion of the licensed professional engineer of record. This allows the engineer to balance other design requirements, such as arc flash, with selectivity needs.

When designing a system for selectivity per NEC requirements, it is important to know exactly how the AHJ has defined selectivity requirements and how they are verified and enforced.

Selective System Design Considerations

Ground Fault Protection

Some selectivity requirement interpretations of the *Code* exclude ground fault protection because it is not specifically addressed in Article 700, 701 or 708. Article 100 defines “Coordination” as:

“Localization of an overcurrent condition to restrict outages to the circuit or equipment affected, accomplished by the choice of overcurrent protective devices and their ratings or settings.”

“Overcurrent” is defined as:

“Any current in excess of the rated current of equipment or the ampacity of a conductor. It may result from overload, short circuit, or ground fault.”

Even though ground fault selectivity is not expressly mentioned in Articles 700, 701, and 708, it is implied through the overriding NEC definitions of “selectivity” and “overcurrent.”

Traditionally, the shape of a ground fault protection characteristic applied on low voltage circuit breakers would be called a “definite time” or “L-shaped” characteristic. (Note: Often, ground fault relays or ground fault protection integrated with circuit breaker trips will offer a way to cut off the bottom left corner of the “L.” This cut-off corner is usually in the shape of an $I^2t=K$ diagonal line on the TCC.)

Typical GF protection characteristics are illustrated in the low voltage circuit breaker phase and ground protection characteristics below. Their dissimilar shapes make selective coordination difficult at best. The NEC (Article 230.95) requires that ground fault protection be applied on solidly grounded 480 volt service entrances, 1000 amperes and larger.

Hospitals and other healthcare facilities with critical care or life support equipment are required to have a second level of ground fault protection beneath the service entrance (NEC Article 517.17(B)). The NEC-stipulated maximum ground fault pick-up setting is 1200 amperes and clearing time is limited by a requirement that a 3000A fault must be cleared in one second or less (Article 230.95(A)). Emergency system supply sources are exempted from these requirements.

Figure 2A is a one line diagram with two levels of ground fault protection as required by NEC Article 517. Figure 2B diagrams the selective device settings for this one-line diagram. Ground fault relay settings for the 4000A main and 1200A branch feeder are selective and at the maximum allowed by the NEC. The next device below the 1200A branch is a 250A OCPD. Note that there is significant overlap between the ground fault relays and the 250A device TCCs.

Traditional system designs would size the 250A OCPD to 600A or possibly 800A, making this non-selective situation worse. In this and many similar situations involving phase and ground fault protection, this system would not be fully selective for ground faults, as an upstream OCPD could trip sooner than the downstream OCPD.

MCCB Layer Limitations - Riser / Feed Through Lug Panels

Some traditional electrical system designs have utilized a “waterfall” of electrical distribution panels of declining ampacities, i.e., a series of progressively smaller electrical distribution panels connected to larger upstream panels. This concept is popular because it allows the size and cost of the distribution panels and feeder cables to be reduced further from the service entrance point. While this has been a satisfactory practice when long time and short time selectivity is considered, the practice increases the difficulty of achieving “fully selective” solutions.

For “fully selective” designs, it is desirable to limit the number of selective circuit breaker layers as there are a limited number of selective molded case circuit breaker (MCCB) pairings available. If you consult GE’s (or other manufacturers’) circuit breaker instantaneous selectivity tables, you will usually find three or, in some circumstances, four layers of molded case circuit breakers that can be made fully selective.

With a limited number of fully selective MCCB layers in mind, the best electrical distribution design strategy is to limit the number of selective layers by utilizing feed-through lugs or riser panels of the same ampacity when sub-panels are required. When feeder cables and panels are all the same ampacity, only one layer of protection is required to protect them.

In doing so, the tradeoff is the elimination of a local main circuit breaker. Some designs will utilize a main disconnect at each panel to allow local isolation of a panel. Care must be exercised if a molded case switch (MCS) is used as a main disconnect. The MCS will have an IOC override in the switch to protect it from damage resulting from high magnitude fault currents. This instantaneous override must be considered as part of the selectively coordinated system.

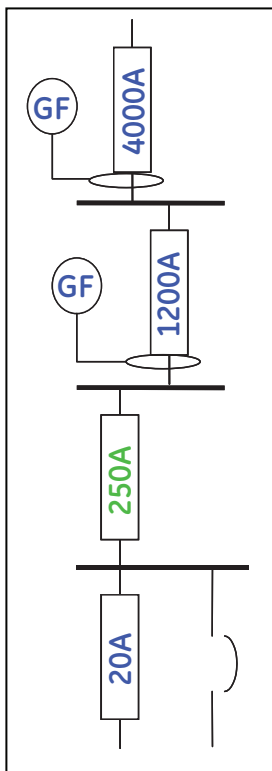

Figure 2A

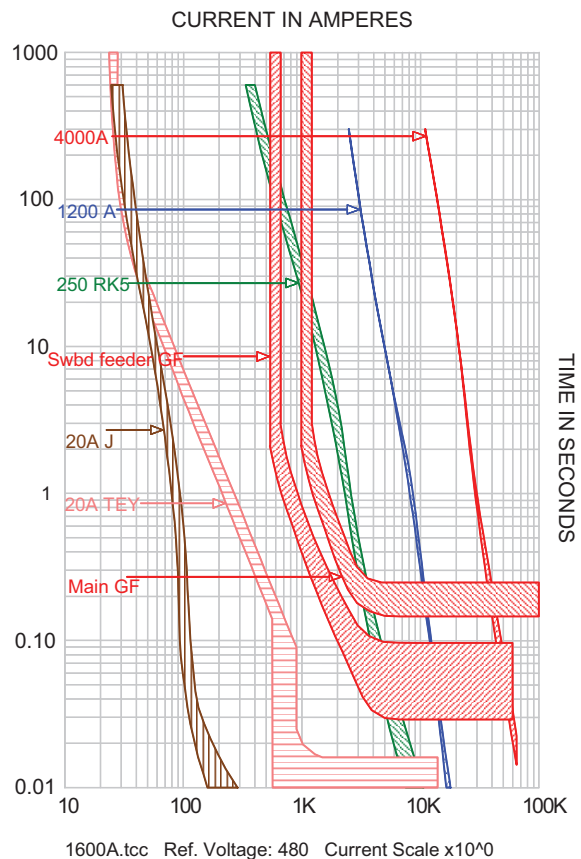
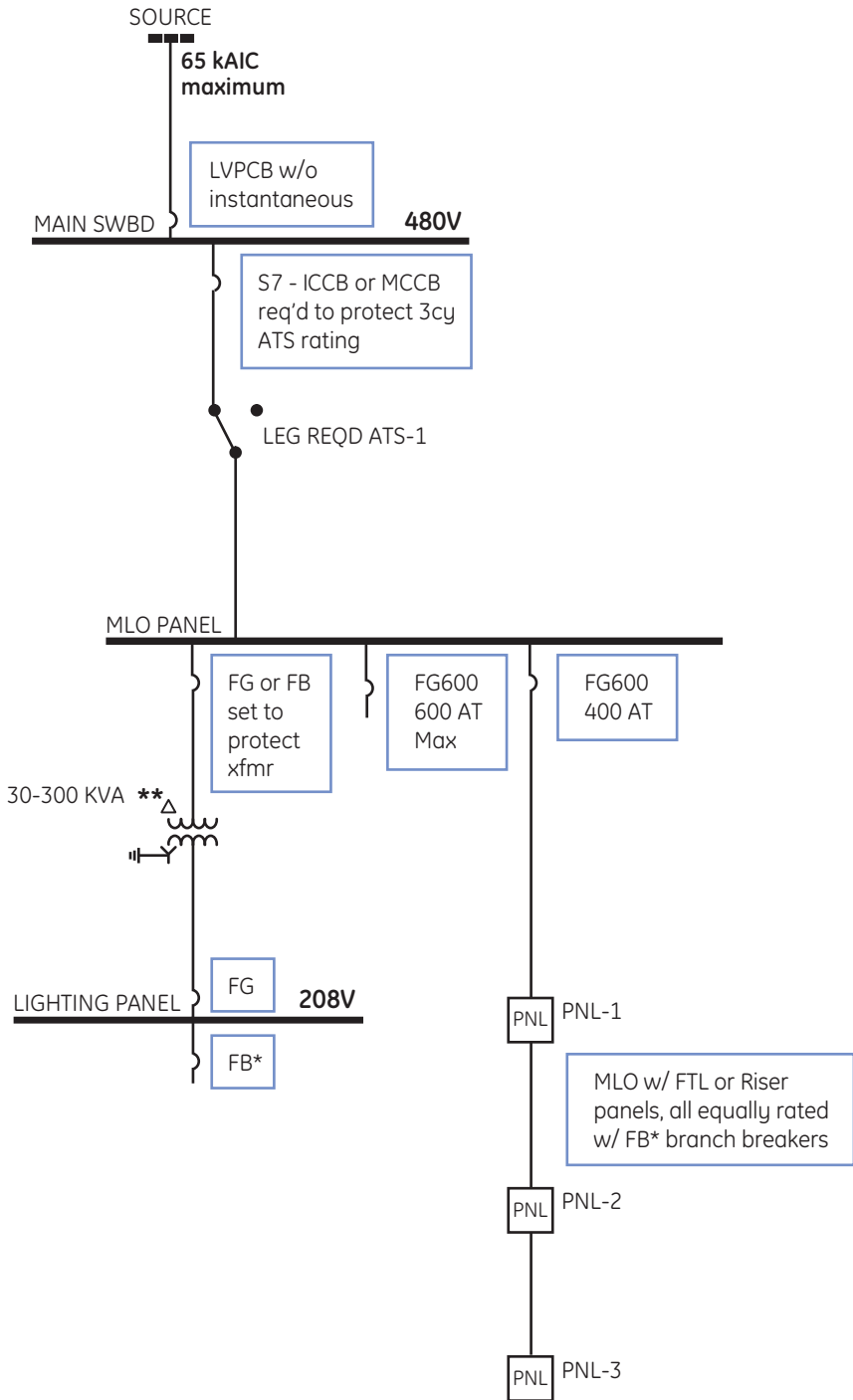

Figure 2B

In Figure 3, the 400 ampere feeder is feeding three downstream panels. With the use of riser panels of the same ampacity, only two layers of selective breakers would be needed. If a traditional design strategy of progressively smaller sub-panels had been used, four layers of fully selective circuit breakers would be required for the waterfall of declining ampacities.

Fully Selective Circuit Breaker Options
For Systems with 65 kAIC or less



* TEY or THQ MCCBs may be used, but only if the maximum AIC specified in DET-537 is not exceeded.
 ** See selectivity templates for details of transformer

Figure 3

Automatic Transfer Switch (ATS) Protection

Most ATSs built for use in North America are manufactured in accordance with the UL 1008 standard, which references UL 489 for molded case circuit breakers. Furthermore, many ATS manufacturers provide application data specifying which MCCBs are appropriate for protecting the ATS ampacity and short circuit withstand ratings. In general, most ATSs are designed to be protected with circuit breakers that have integral IOC protection functions.

In some fully selective protection schemes, it may be necessary to protect an ATS with a low voltage power circuit breaker (LVPCB) applied without an IOC function. This may be a non-conforming application, which might require special consideration by the ATS manufacturer. Some ATS manufacturers have published withstand data on such applications, while others are considering future products with higher withstand time ratings in view of the new selectivity requirements.

Switchboard Protection

Switchboards, distribution panels and lighting panels utilize MCCBs, ICCBs or LVPCBs with IOC functions. Therefore, the withstand ratings of these boards and panels are usually based on 3 cycles. Similar to the ATS ratings discussed above, LVPCBs without an IOC function should not be used to protect a switchboard unless special application consideration has been given to its withstand rating. Some manufacturers have 30 cycle withstand ratings for specific switchboard designs. If selectivity requirements result in the use of LVPCBs without an IOC function or very high IOC settings, it is important to know the withstand ratings of the downstream equipment.

GE has introduced UL Listed Spectra Series Switchboards rated for 30 cycles of short circuit withstand. Since UL 891 does not have standard requirements for 30 cycle ratings, ANSI 37.20 was used to validate the switchboard performance. These switchboard designs enable them to withstand longer duration faults.

Transformer / Current Limiting Reactor Applications

Considerations for NEC "fully selective" applications focus on the selective performance of circuit breaker pairs in the IOC regions of their TCCs. Usually, higher short circuit currents limit the options for pairs of selective breakers. Consequently, some electrical designs use one-to-one ratio transformers or current limiting reactors to restrict fault current magnitudes. This works well where one of these devices can provide a small amount of series reactance to control the short circuit current to a magnitude where more options for selective breaker pairings are available. It may not be effective if two-to-one or three-to-one reductions in short circuit current magnitude would be required to make selectivity possible.

Design Tips Summary

- Note the actual calculated short circuit currents for the critical circuit buses on the bid drawings.
- Define the circuits and sources that must be made selective, according to the local AHJ (preferable), the end customer or the engineer of record.
- Limit service entrance short circuit current to less than 65 kA whenever possible.
- Limit the "critical" feeder sizes in the service entrance gear to 1200A maximum.
- Limit the number of MCCB selective layers below an ATS to two if using a 1200A frame MCCB to protect the ATS.
- If ATS or switchboards are protected by an LVPCB without IOC, this equipment will require a 30 cycle short circuit withstand rating.
- Utilize main lug only (MLO) with FTL or riser panels to minimize required layers of fully selective circuit breakers.
- Increasing the frame size of an ICCB or MCCB may increase maximum short circuit current selectivity with a downstream breaker.
- Small lighting transformer impedance can be used to limit the secondary short circuit current, with resulting full selectivity (secondary main IOC set above the secondary short circuit current).
- For systems with 35kA short circuit current or less:
 - Utilize an LVPCB without IOC as the service entrance main as the fifth and top layer of selective protection.
 - Utilize PB II as the fourth layer of selective protection.
 - Utilize S7 MCCB as the third layer of selective protection.
 - Utilize FG MCCB as the second layer of selective protection.
 - Utilize FB, TEY, THQB MCCBs (depending on short circuit current requirement and voltage at this level) as the bottom branch device layer of selective protection system.
- For systems with 65kA short circuit current or less,
 - Utilize an LVPCB without IOC as the service entrance main as the fifth and top layer of selective protection.
 - Utilize an LVPCB without IOC as the fourth layer of selective protection.
 - Utilize S7 MCCB as the third layer of selective protection.
 - Utilize FG MCCB as the second layer of selective protection.
 - Utilize FB, TEY, THQB MCCBs (depending on short circuit current requirement and voltage at this level) as the bottom branch device layer of selective protection system.
- Utilize lighting transformer TCC templates to define breaker applications for transformer protection and fully selective protection.
- Contact GE Specification Engineers in Florida for assistance with 0.1 second selectivity requirements.

Selectivity for Existing Systems

Several projects have been reviewed where NEC requirements for selectivity on critical circuits have been stipulated for add-on systems within pre-existing power distribution systems. Interpretations of requirements for these situations have varied significantly.

Assuming that the critical circuits in the original system were designed to the “traditional” selective coordination requirements, adding new critical circuits under the existing system would probably result in a non-selective system. Under fault conditions in the new portion of the circuit, the upstream, pre-existing breakers would probably be non-selective, resulting in a potential shutdown of the entire new system for some faults. Where devices with instantaneous trips from different manufacturers are mixed, it is unlikely that there is enough data to determine the selectivity capability between them. The one application exception to this would be the addition of a new sub-system under an ANSI circuit breaker that was applied without an IOC function or a circuit breaker with an IOC threshold larger than the AIC.

In some cases, a variance from the Code requirement has been requested and granted based on considerations of the difficulty in analyzing or achieving selectivity for systems involving a mix of manufacturers. If absolute adherence to the new NEC requirements for add-on systems is required, this will probably result in costly replacement of existing circuit breakers and possibly equipment. Often, fully selective circuit breaker pairings and associated equipment may be larger and more expensive than breakers and equipment designed around traditional selectivity definitions. Therefore, an expansion of the space allocated to original equipment may be required.

Arc Flash Considerations

At the core of fully selective designs based on NEC Coordination (fully selective) requirements is the concept of coordination of circuit breaker OCPD time-current characteristics. Practically, this means that the circuit breaker immediately upstream of the breaker closest to the fault will be set (delayed or desensitized) to prevent it from operating until the downstream breaker clears the fault.

Considering that a typical 1500 kVA service entrance and associated power distribution system designed for full selectivity may have five layers of coordinated circuit breakers, the time delayed response of the service entrance main breaker may be considerable. This time delay could correspond to high arc flash incident energy and a correspondingly high Hazard Risk category classification.

The Standard for Electrical Safety in the Workplace, NFPA70E, requires that all electrical hazards be identified by qualified personnel before work on electrical equipment is undertaken. Usually, this requires assessment of arc flash hazard. Ideally, an Arc Flash Study of the electrical system should be considered during design so that the consequences of design decisions, *including those made for selectivity purposes*, are understood.

Increasing OCPD pickup settings, increasing IOC settings and adding time delays to obtain fully selective design can have a significant impact on available incident energy. For systems likely to be serviced while energized, these time delays may cause serious risk to personnel. High incident energy levels may force the system to be shut down before any work can be performed. Additionally, excessive energy levels and time delayed (slow) protective device response may allow extensive fault related damage, requiring extensive down time and repair.

Maximum AIC Ratings for Popular, Fully Selective Circuit Breaker Pairs

Instantaneous selectivity AIC values in these tables are for 277/480V and 120/208V ratings. THQB breakers listed are rated for 120/208V. SF, SE, FB, TEY and THQB breakers will probably not be selective with any breakers applied downstream from them.

TCC	Selectivity to be determined via TCC overlay method using specific OCPD settings
	Selectivity probably not achievable

Table 1A

Main Breaker	Branch Breaker	(ABB) S7H **		Record Plus FG			Spectra SF	Spectra SE	Record Plus FE	Record Plus FB	Frame TEYF
	No. Poles	3	3	3,2	3,2	3,2	3,2	3,2	3,2	3,2,1	3,2,1
	Max Sensor or Trip*	1200	1000	600	400	250	250	150	250	100	30
WavePro (LS Trip)	5000	65.0	65.0	100.0	100.0	100.0	100.0	100.0	100.0	100.0	14.0
	4000	65.0	65.0	100.0	100.0	100.0	100.0	100.0	100.0	100.0	14.0
	3200	65.0	65.0	100.0	100.0	100.0	100.0	100.0	100.0	100.0	14.0
	2000	65.0	65.0	65.0	65.0	65.0	65.0	65.0	65.0	65.0	14.0
	1600	65.0	65.0	65.0	65.0	65.0	65.0	65.0	65.0	65.0	14.0
	800			NIS	65.0	65.0	65.0	65.0	65.0	65.0	65.0
WavePro (LSI Trip)	5000	31.5	31.5	64.7	64.7	64.7	97.5	100.0	100.0	100.0	14.0
	4000	32.4	32.4	69.0	69.0	69.0	100.0	100.0	100.0	100.0	14.0
	3200	37.4	37.4	100.0	100.0	100.0	100.0	100.0	100.0	100.0	14.0
	2000	27.0	27.0	44.0	44.0	44.0	67.4	71.2	100.0	100.0	14.0
	1600	21.6	21.6	25.0	25.0	25.0	40.0	40.0	71.3	100.0	14.0
	800			NIS	11.0	11.0	11.0	13.0	14.2	35.0	14.0
Power Break II	4000	32.4	32.4	69.0	69.0	69.0	100.0	100.0	100.0	100.0	14.0
	3000	35.1	35.1	85.0	85.0	85.0	100.0	100.0	100.0	100.0	14.0
	2500	29.3	29.3	54.0	54.0	54.0	81.6	90.0	100.0	100.0	14.0
	2000	27.0	27.0	44.0	44.0	44.0	67.4	73.0	100.0	100.0	14.0
	1600	21.6	21.6	25.0	25.0	25.0	40.0	40.0	71.3	100.0	14.0
	800			TCC	11.0	11.0	11.0	13.0	14.2	35.0	14.0
S7H (ABB)	1200			65.0	65.0	65.0	65.0	65.0	65.0	65.0	14.0
	1000			65.0	65.0	65.0	65.0	65.0	65.0	65.0	14.0
Record Plus FG	600				TCC	TCC	TCC	TCC	100.0	65.0	14.0
	400					TCC	TCC	TCC	TCC	65.0	14.0
	250						TCC	TCC	TCC	65.0	14.0
Record Plus FE	250									14.0	

* For Record Plus FG & FE and ABB S7, maximum IOC is based on sensor size

** S7 LTPU is 0.4-1.0 x sensor size and does not use rating plugs

Table 1B

Main Breaker	Branch Breaker	Frame TEY						Q-Line THQB				
	No. Poles	3,2	1	3,2	1	3,2	1	2	3, 2	3, 2, 1	3	1
	Max Sensor or Trip	100	100	60	60	30	30	125	100	60	30	30
WavePro (LS Trip)	5000	14.0	14.0	14.0	14.0	14.0	14.0	22.0	22.0	22.0	22.0	22.0
	4000	14.0	14.0	14.0	14.0	14.0	14.0	22.0	22.0	22.0	22.0	22.0
	3200	14.0	14.0	14.0	14.0	14.0	14.0	22.0	22.0	22.0	22.0	22.0
	2000	14.0	14.0	14.0	14.0	14.0	14.0	22.0	22.0	22.0	22.0	22.0
	1600	14.0	14.0	14.0	14.0	14.0	14.0	22.0	22.0	22.0	22.0	22.0
	800	14.0	14.0	14.0	14.0	14.0	14.0	22.0	22.0	22.0	22.0	22.0
WavePro (LSI Trip)	5000	14.0	14.0	14.0	14.0	14.0	14.0	22.0	22.0	22.0	22.0	22.0
	4000	14.0	14.0	14.0	14.0	14.0	14.0	22.0	22.0	22.0	22.0	22.0
	3200	14.0	14.0	14.0	14.0	14.0	14.0	22.0	22.0	22.0	22.0	22.0
	2000	14.0	14.0	14.0	14.0	14.0	14.0	22.0	22.0	22.0	22.0	22.0
	1600	14.0	14.0	14.0	14.0	14.0	14.0	22.0	22.0	22.0	22.0	22.0
	800	12.8	12.8	12.8	12.8	12.8	12.8	18.1	18.1	18.1	18.1	18.1
Power Break II	4000	14.0	14.0	14.0	14.0	14.0	14.0	22.0	22.0	22.0	22.0	22.0
	3000	14.0	14.0	14.0	14.0	14.0	14.0	22.0	22.0	22.0	22.0	22.0
	2500	14.0	14.0	14.0	14.0	14.0	14.0	22.0	22.0	22.0	22.0	22.0
	2000	14.0	14.0	14.0	14.0	14.0	14.0	22.0	22.0	22.0	22.0	22.0
	1600	14.0	14.0	14.0	14.0	14.0	14.0	22.0	22.0	22.0	22.0	22.0
	800	12.8	12.8	12.8	12.8	12.8	12.8	18.1	18.1	18.1	18.1	18.1
S7H (ABB)	1200	14.0	14.0	14.0	14.0	14.0	14.0	22.0	22.0	22.0	22.0	22.0
	1000	14.0	14.0	14.0	14.0	14.0	14.0	22.0	22.0	22.0	22.0	22.0
Record Plus FG	600	6.0	6.0	10.0	10.0	14.0	14.0	22.0	22.0	22.0	22.0	22.0
	400	4.0	4.0	10.0	10.0	14.0	14.0	22.0	22.0	22.0	22.0	22.0
	250	2.5	2.5	2.5	2.5	14.0	14.0	2.5	2.5	10.0	22.0	22.0
Record Plus FE	250	TCC	TCC	TCC	TCC	10.0	10.0	TCC	TCC	4.0	6.0	14.0

Table 1C

120/240V breaker ratings

For 120/240V breaker pairs not listed below, use selective values from the 208 & 480V table above.

Main Breaker	Branch Breaker	Record Plus FG			Spectra SF	Spectra SE	Record Plus FB
	No. Poles	3,2	3,2	3,2	3,2	3,2	3,2,1
WavePro (LSI Trip)	Max Sensor or Trip	600	400	250	250	150	100
	5000	130	130	130	130	130	100
	4000	130	130	130	130	130	100
	3200	130	130	130	130	130	100
	2000	130	65	65	130	130	65
	1600	130	65	65	130	130	65
Power Break II	800	TCC	10	10	130	130	65
	4000	100	100	100	100	100	100
	3000	100	100	100	100	100	100
	2500	92	92	92	100	100	100
	2000	75	75	75	85	85	85
	1600	42	42	42	72	72	85
800	TCC	10	10	14	17	32	

Table 2

GE Circuit Breaker / Equipment Combinations

Breakers		Equipment												
		Enclosure Mounted	A-Series II Panelboards			A-Series II Powerpanel	Spectra Powerpanels	Switchboards			Switchgear			
			AQ	AE	AD			AV-1,2,5	AV-3	PB II	AKD10	Entellisys	AKD20	
Main	WavePro without IOC							✓	✓	✓	✓			
	WavePro with IOC							✓	✓	✓	✓			
	EntelliGuard without IOC											✓		
	EntelliGuard with IOC											✓		
	EntelliGuard G without IOC												✓	
	EntelliGuard G with IOC												✓	
	Power Break II							✓	✓	✓				
	ABB S7						✓	✓						
	Record Plus FG			8/08	✓		✓							
	Record Plus FE			2009	2009									
Feeder	WavePro without IOC								✓		✓			
	WavePro with IOC								✓		✓			
	EntelliGuard without IOC											✓		
	EntelliGuard with IOC											✓		
	EntelliGuard G without IOC												✓	
	EntelliGuard G with IOC												✓	
	Power Break II	✓							✓	✓				
	ABB S7	ABB						✓						
	Record Plus FG						✓	✓						
	Record Plus FE					2009	8/08	✓						
	Record Plus FB				✓	3	✓	8/08						
	TEY / TEYF	✓		✓		3	✓							
	THQ	✓	✓	✓		3	✓							

Appendix

Selective Time–Current Curve Templates

The followed time-current curves were composed with the following objectives:

1. Achieve full selectivity (LT, ST and IOC) between each pair of circuit breakers applied
2. Provide required NEC transformer protection
3. Provide recommended ANSI through fault protection of transformers
4. Provide the secondary power panel protection in accordance with its ampacity

(Note: To be “fully selective,” there must be no overlap of the long time and short time characteristics of an upstream and downstream circuit breaker pair. If the IOC function of this pair of breakers overlap, then their instantaneous selectivity must be identified as selective in the manufacturer’s instantaneous overcurrent selectivity application literature.)

While it may be desirable to have the primary and secondary main circuit breakers selective with one another, it is not usual when applying MCCBs to protect transformers. In the 2008 NEC, a specific exception was added to exempt selectivity requirements from the primary and secondary mains. The branch circuit breakers shown are the largest possible breakers and trips that will be fully selective with both the upstream primary and secondary main transformer circuit breakers. If selectivity between the branch breakers and the upstream secondary main is not apparent because of IOC TCC overlap, the application is fully selective based on the tabular pairing cited in DET-537, GE Overcurrent Device Instantaneous Selectivity Tables.

One other item of note is that the maximum AIC values shown in DET-537 are symmetrical values. All analysis and testing done to validate these numbers were done with the appropriate standard based X/R value and corresponding asymmetrical offset. The equivalent symmetrical value was placed in the tables. It has long been standard practice to terminate the IOC function on a TCC at the maximum asymmetrical value of fault current, as IOC functions are often responsive to the peak value of current.

The partial system templates diagrammed on the following TCCs were laid out and modeled based on a maximum fault current of 65 kA at 480V, with an X/R ratio of 4.9. Transformer impedances used are the minimum for which a full selectivity solution could be achieved. Also noted on the TCCs are the typical GE transformer impedances for aluminum wound, 150°C rated transformers. In every case, the impedance diagrammed is equal to or less than the typical GE value. To make the solution as conservative as possible, no or negligible cable impedances were included in the short circuit calculations.

While Article 450 of the NEC requires that transformers be properly protected from overcurrent conditions, it allows several alternative approaches to achieve protection. For 480V to 120/208V lighting transformers, 15 kVA and larger, the protection requirements are described in Table 450.3B of the NEC. The two options described are to use a circuit breaker as the primary main rated at no more than 250% of the primary ampere rating and a secondary main circuit breaker rated at no more than 125% of the secondary. (Note: See NEC Table 450.3 and associated notes for additional application allowances and restrictions.) It is also permissible to use only a primary main circuit breaker rated at no more than 125% of the primary ampacity.

In general, since the ANSI “through” fault protection criteria is a recommendation, it is desirable to have the ANSI protection characteristic to the right of the primary and secondary circuit breaker TCCs. However, it is the standard practice that adequate protection is still provided if most of the ANSI characteristic is to the right of the secondary main TCC.

In the TCCs that follow, A is always the transformer primary main and B is the secondary main circuit breaker.

15 kVA Transformer Template (with Record Plus Type FB Primary Main)

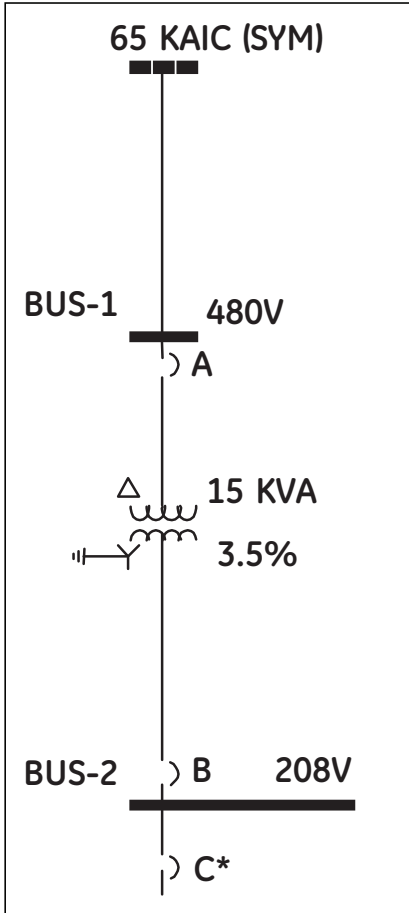

- (A) GE Record Plus MCCB**
 Frame Type: FBN
 Frame Size: 100A
 Trip: 25A
- (B) GE TEY MCCB**
 Frame Type: TEY
 Frame Size: 100A
 Trip: 50A
- (C)* GE Q-Line MCCB**
 Frame Type: THQB
 Frame Size: 100A
 Trip: 20A

Notes:

Where an overlap of the time-current curve, instantaneous overcurrent characteristics seem to indicate non-selectivity, GE Overcurrent Instantaneous Selectivity Tables, DET-537, were used to validate selective operation.

Unless otherwise noted, overcurrent protective devices shown are for all available pole configurations.

GE typical transformer impedance: 150°C rise, aluminum winding, $Z = 6.1\%$
 This $Z\%$ is equal to or greater than the minimum allowed on this coordination plot

* Base layer circuit breaker settings are "not to exceed" values

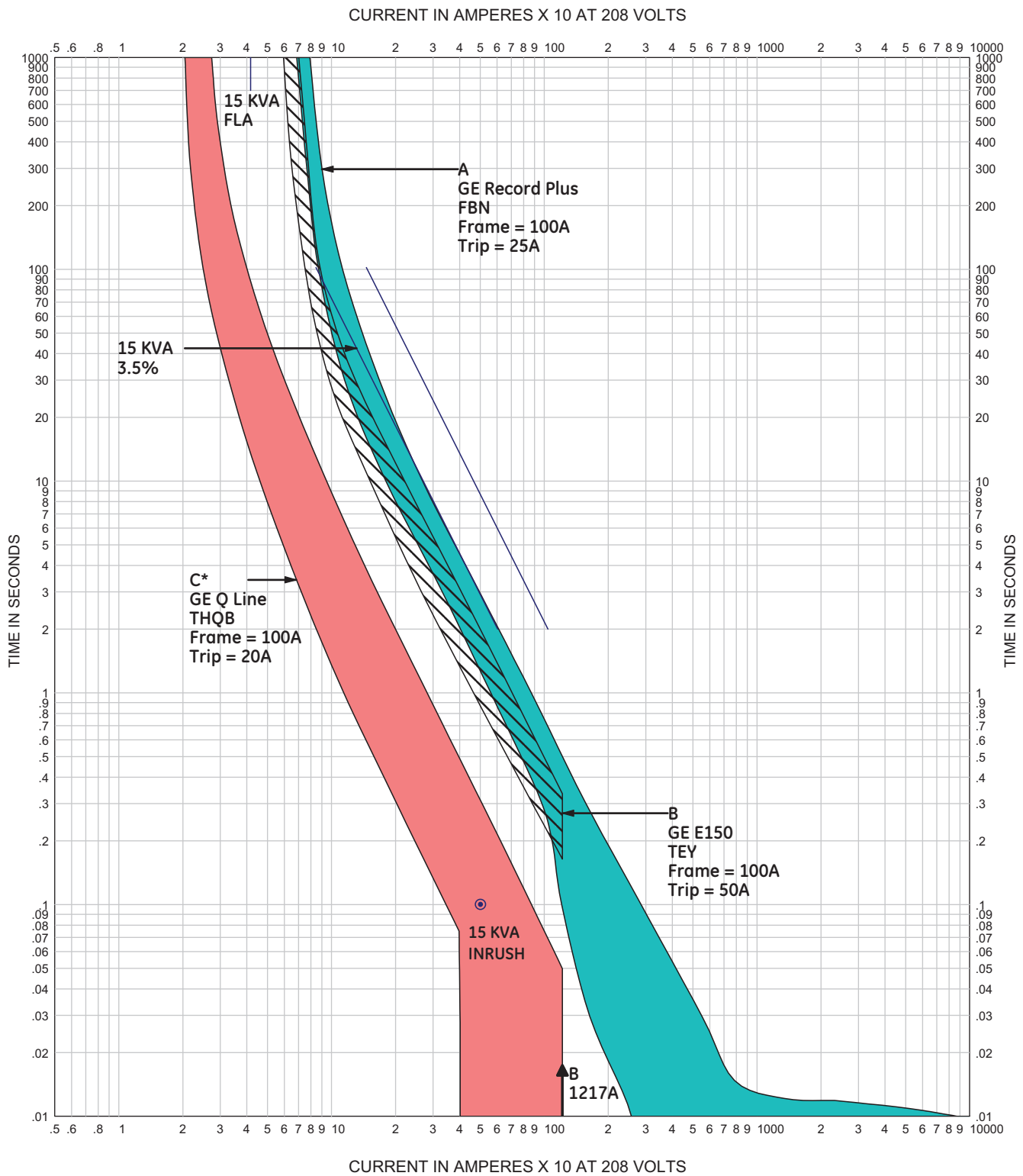



Time-current Curve

Fully Selective Solution for 15 kVA Transformer

The following parameters are the basis of the above selective coordination plot:

- Minimum allowable Z% = 3.5%
- 65 kA (X/R=4.9) @ 480V; 1.2 kA @ 208V

30 kVA Transformer Template
(with Record Plus Type FB Primary Main)

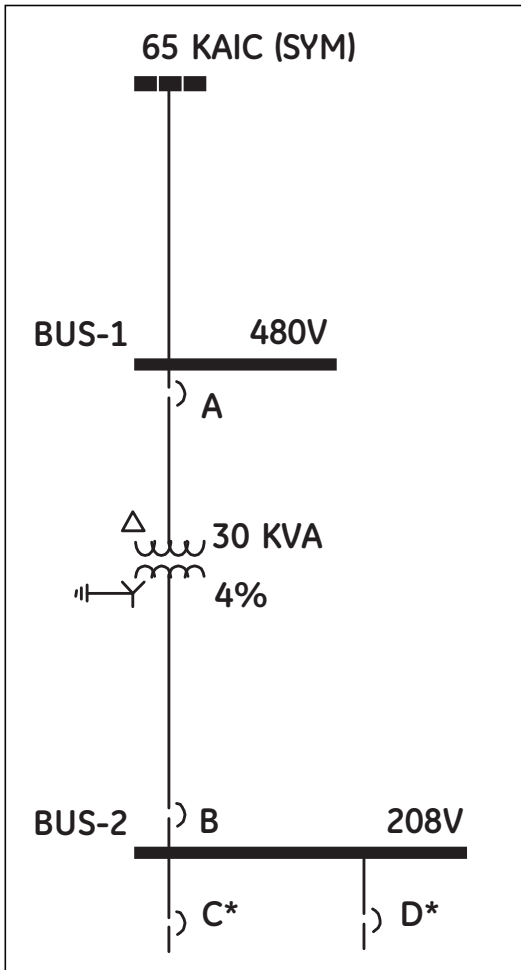

- (A) GE Record Plus MCCB**
 Frame Type: FBN
 Frame Size: 100A
 Trip Plug: 70A
- (B) GE Record Plus MCCB**
 Frame Type: FGN
 Frame Size: 600A
 Sensor: 250A
 Rating Plug: 100A
 IOC Setting: 11X (2750A)
- (C)* GE Q-Line MCCB**
 Frame Type: THQB Model C
 Frame Size: 100A-1,2P
 Trip: 50A
- (D)* GE Q-Line MCCB**
 Frame Type: THQB
 Frame Size: 100A
 Trip: 35A

Notes:

Where an overlap of the time-current curve, instantaneous overcurrent characteristics seem to indicate non-selectivity, GE Overcurrent Instantaneous Selectivity Tables, DET-537, were used to validate selective operation.

Unless otherwise noted, overcurrent protective devices shown are for all available pole configurations.

GE typical transformer impedance: 150°C rise, aluminum winding, Z = 5.6%
 This Z% is equal to or greater than the minimum allowed on this coordination plot

* Base layer circuit breaker settings are "not to exceed" values

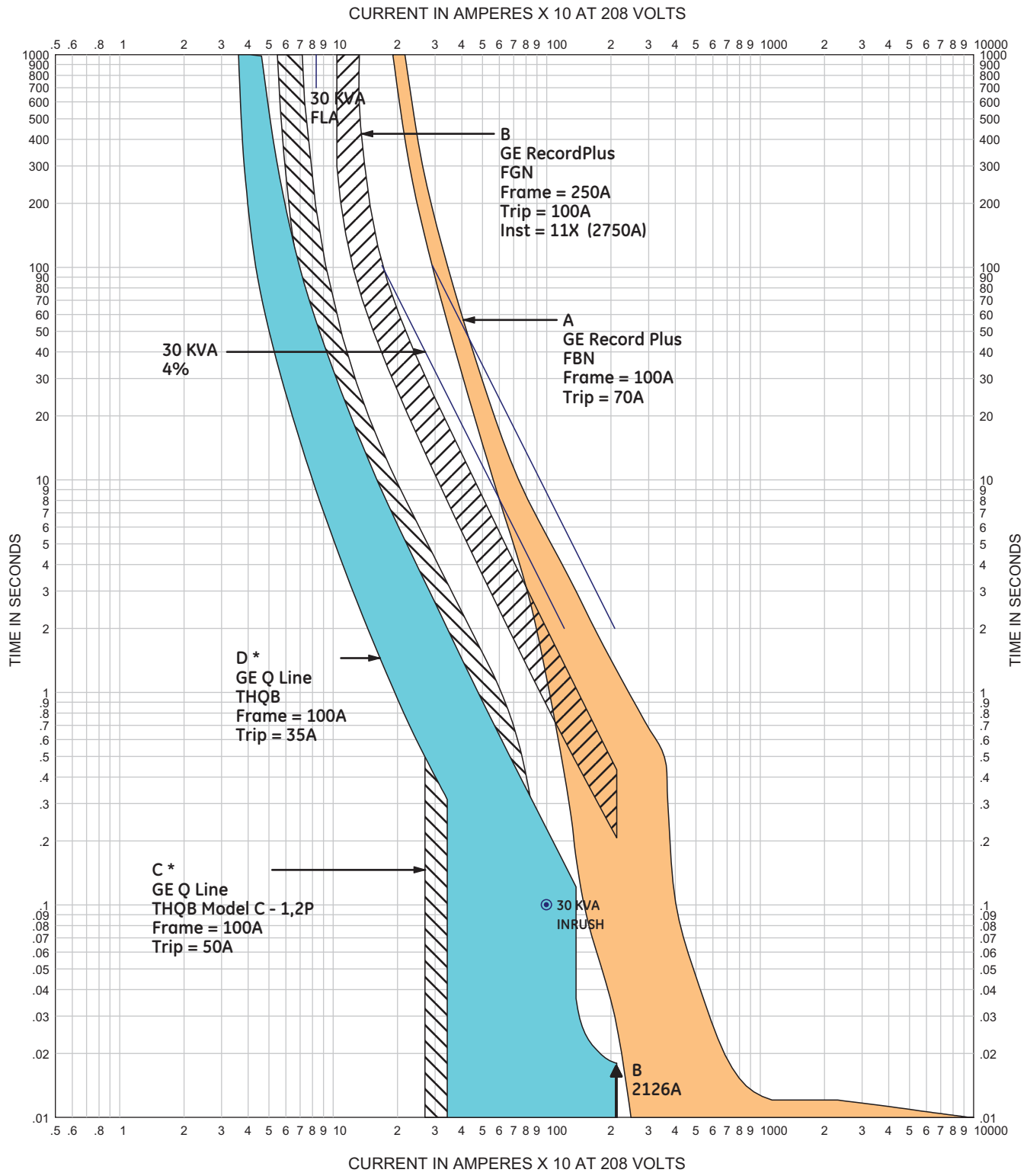



Time-current Curve

Fully Selective Solution for 30 kVA Transformer

The following parameters are the basis of the above selective coordination plot:

- Minimum allowable Z% = 4.0%
- 65 kA (X/R=4.9) @ 480V; 2.1 kA @ 208V

30 kVA Transformer Template
(with Record Plus Type FG Primary Main)

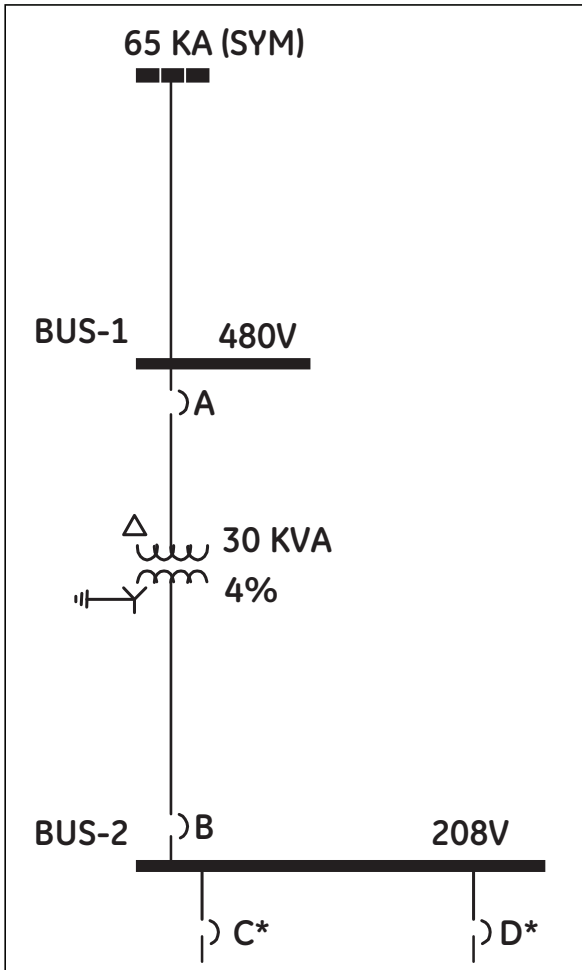

- (A) GE Record Plus MCCB**
 Frame Type: FGN
 Frame Size: 600A
 Sensor: 250A
 Rating Plug: 100A
 IOC Setting: 11X (2750A)
- (B) GE Record Plus MCCB**
 Frame Type: FGN
 Frame Size: 600A
 Sensor: 250A
 Rating Plug: 100A
 IOC Setting: 11X (2750A)
- (C)* GE Q-Line MCCB**
 Frame Type: THQB
 Frame Size: 100A
 Trip: 50A
- (D)* GE Q-Line MCCB**
 Frame Type: THQB Model C
 Frame Size: 100A - 1, 2P
 Trip: 60A

Notes:

Where an overlap of the time-current curve, instantaneous overcurrent characteristics seem to indicate non-selectivity, GE Overcurrent Instantaneous Selectivity Tables, DET-537, were used to validate selective operation.

Unless otherwise noted, overcurrent protective devices shown are for all available pole configurations.

GE typical transformer impedance: 150°C rise, aluminum winding, Z = 5.6%
 This Z% is equal to or greater than the minimum allowed on this coordination plot

* Base layer circuit breaker settings are "not to exceed" values

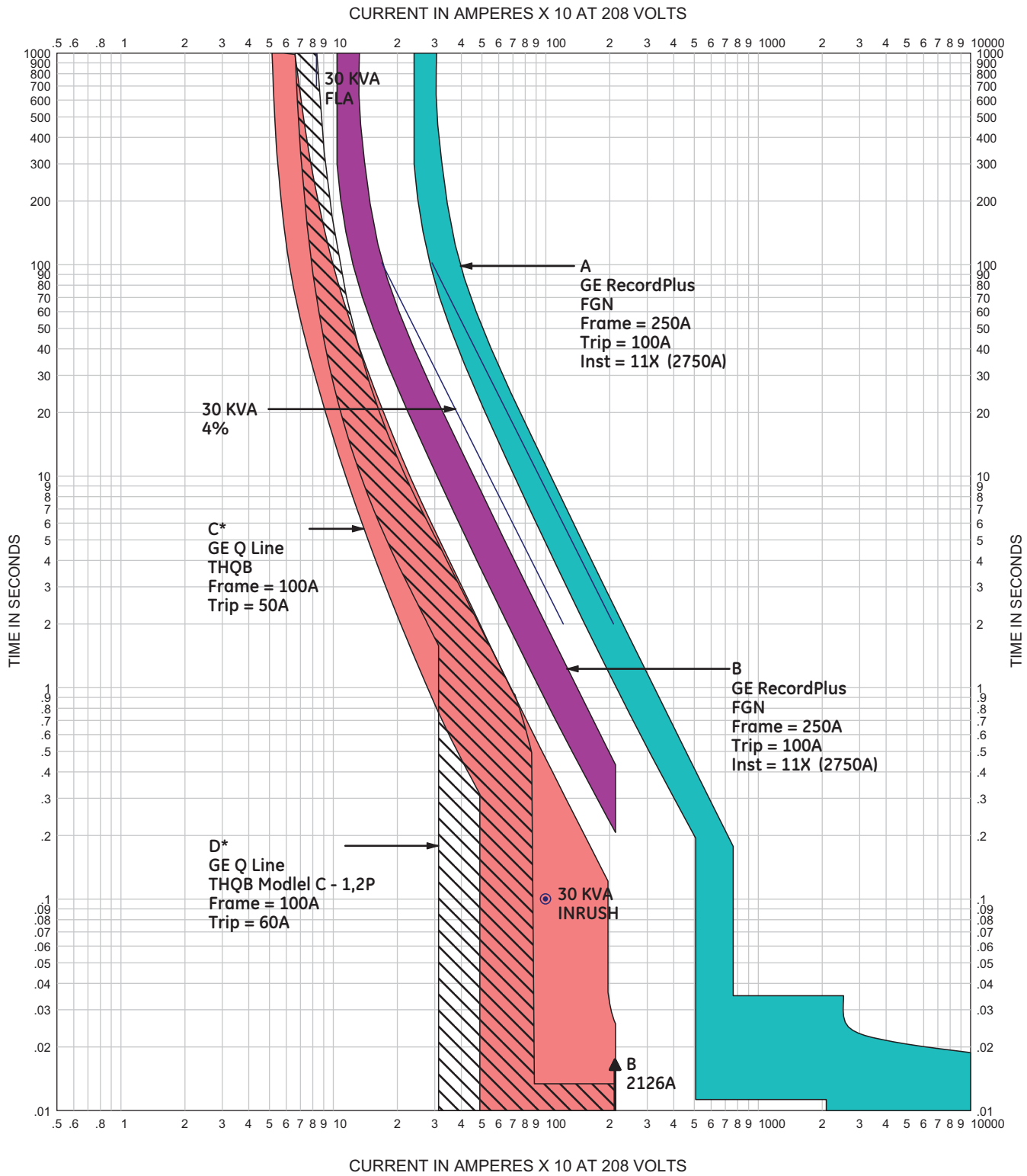



Time-current Curve

Fully Selective Solution for 30 kVA Transformer

The following parameters are the basis of the above selective coordination plot:

- Minimum allowable Z% = 4.0%
- 65 kA (X/R=4.9) @ 480V; 2.1 kA @ 208V

45 kVA Transformer Template
(with Record Plus Type FG Primary Main)

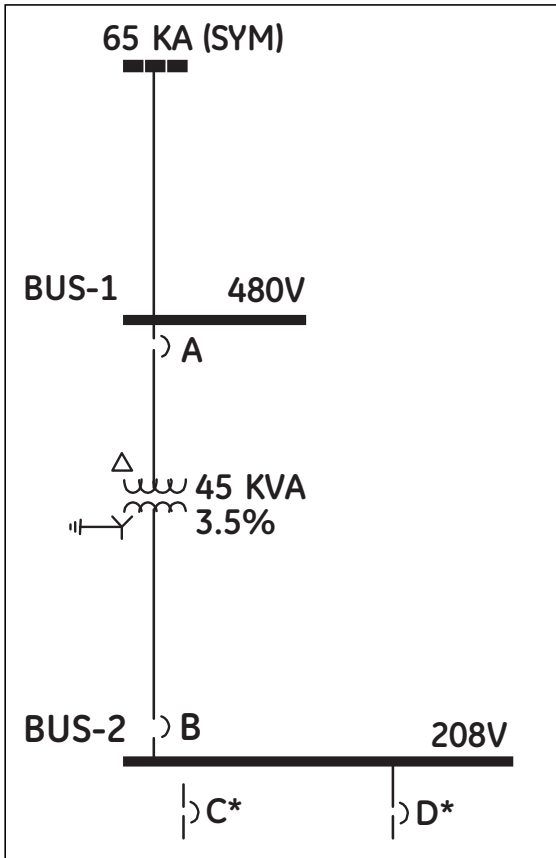

- (A) GE Record Plus MCCB**
 Frame Type: FGN
 Frame Size: 600A
 Sensor: 250A
 Trip: 100A
 IOC Setting: 11X (2750A)

- (B) GE Record Plus MCCB**
 Frame Type: FGN
 Frame Size: 600A
 Sensor: 250A
 Trip: 150A
 IOC Setting: 11X (2750A)

- (C)* GE Q-Line MCCB**
 Frame Type: THQB
 Frame Size: 100A
 Trip: 50A

- (D)* GE Q-Line MCCB**
 Frame Type: THQB Model C
 Frame Size: 100A - 1, 2P
 Trip: 60A

Notes:

Where an overlap of the time-current curve, instantaneous overcurrent characteristics seem to indicate non-selectivity, GE Overcurrent Instantaneous Selectivity Tables, DET-537, were used to validate selective operation.

Unless otherwise noted, overcurrent protective devices shown are for all available pole configurations.

GE typical transformer impedance: 150°C rise, aluminum winding, Z = 5.4%
 This Z% is equal to or greater than the minimum allowed on this coordination plot

* Base layer circuit breaker settings are "not to exceed" values

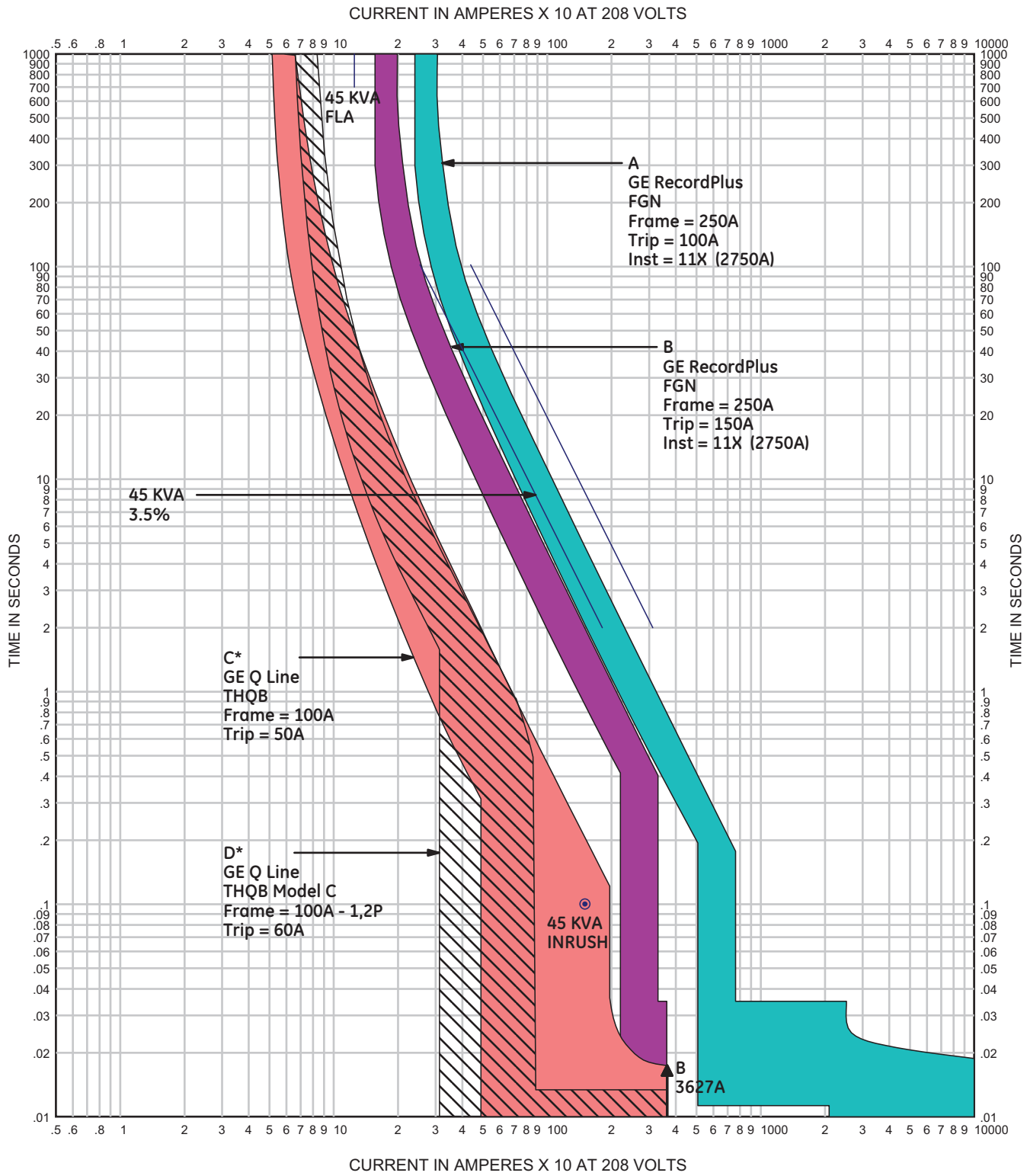

Time-current Curve

Fully Selective Solution for 45 kVA Transformer

The following parameters are the basis of the above selective coordination plot:

- Minimum allowable Z% = 3.5%
- 65 kA (X/R=4.9) @ 480V; 3.6 kA @ 208V

75 kVA Transformer Template
(with Record Plus Type FG Primary Main)

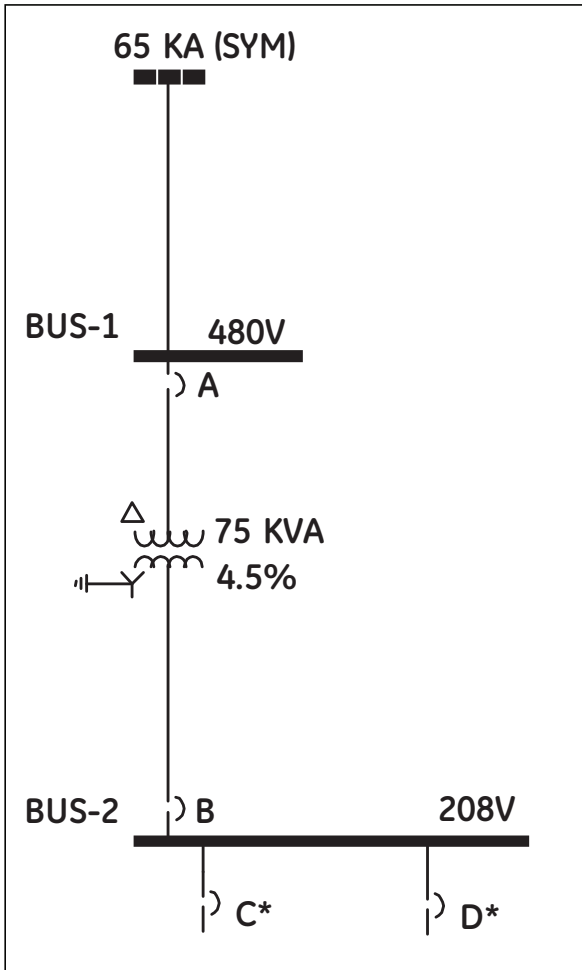

(A) GE Record Plus MCCB
 Frame Type: FGN
 Frame Size: 600A
 Sensor: 250A
 Trip: 110A
 IOC Setting: 11X (2750A)

(B) GE Record Plus MCCB
 Frame Type: FGN
 Frame Size: 600A
 Sensor: 400A
 Trip: 225A
 IOC Setting: 11X (4400A)

(C)* GE Q-Line MCCB
 Frame Type: THQB
 Frame Size: 100A
 Trip: 100A

(D)* GE Q-Line MCCB
 Frame Type: THQB Model C
 Frame Size: 100A – 1, 2P
 Trip: 60A

Notes:

Where an overlap of the time-current curve, instantaneous overcurrent characteristics seem to indicate non-selectivity, GE Overcurrent Instantaneous Selectivity Tables, DET-537, were used to validate selective operation.

Unless otherwise noted, overcurrent protective devices shown are for all available pole configurations.

GE typical transformer impedance: 150°C rise, aluminum winding, Z = 6.0%
 This Z% is equal to or greater than the minimum allowed on this coordination plot

* Base layer circuit breaker settings are “not to exceed” values

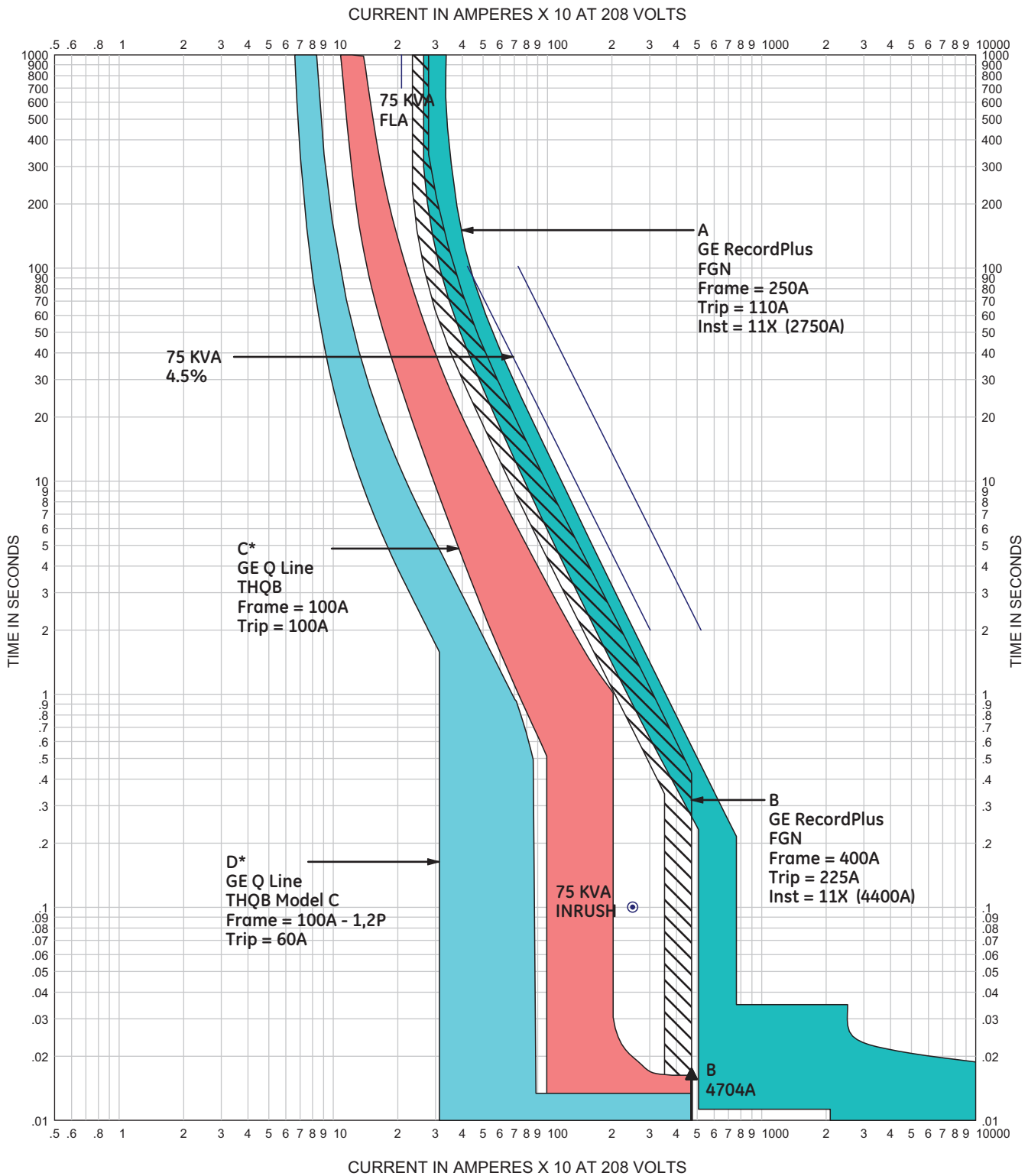

Time-current Curve

Fully Selective Solution for 75 kVA Transformer

The following parameters are the basis of the above selective coordination plot:

Minimum allowable Z% = 4.5%

65 kA (X/R=4.9) @ 480V; 4.7 kA @ 208V

112.5 kVA Transformer Template
(with Record Plus Type FG Secondary Main)

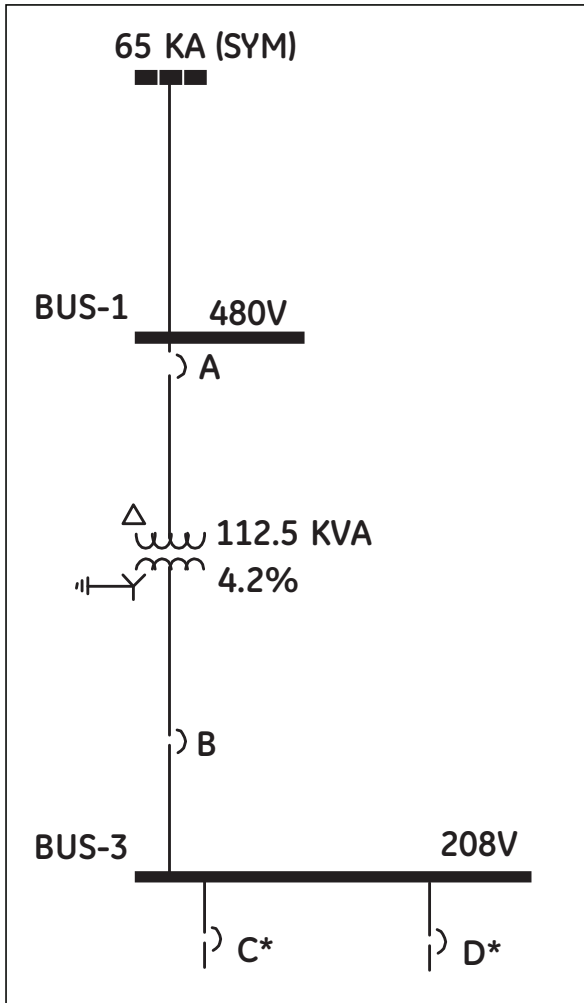

- (A) GE Record Plus MCCB**
 Frame Type: FGN
 Frame Size: 600A
 Sensor: 400A
 Trip: 225A
 IOC Setting: 11X (4400A)
- (B) GE Record Plus MCCB**
 Frame Type: FGN
 Frame Size: 600A
 Sensor: 400A
 Trip: 350A
 IOC Setting: 11X (4400A)
- (C)* GE Q-Line MCCB**
 Frame Type: THQB
 Frame Size: 100A
 Trip: 100A
- (D)* GE TEY MCCB**
 Frame Type: TEY, 3P
 Frame Size: 100A
 Trip: 60A

Notes:

Where an overlap of the time-current curve, instantaneous overcurrent characteristics seem to indicate non-selectivity, GE Overcurrent Instantaneous Selectivity Tables, DET-537, were used to validate selective operation.

Unless otherwise noted, overcurrent protective devices shown are for all available pole configurations.

GE typical transformer impedance: 150°C rise, aluminum winding, Z = 5.9%
 This Z% is equal to or greater than the minimum allowed on this coordination plot

* Base layer circuit breaker settings are "not to exceed" values

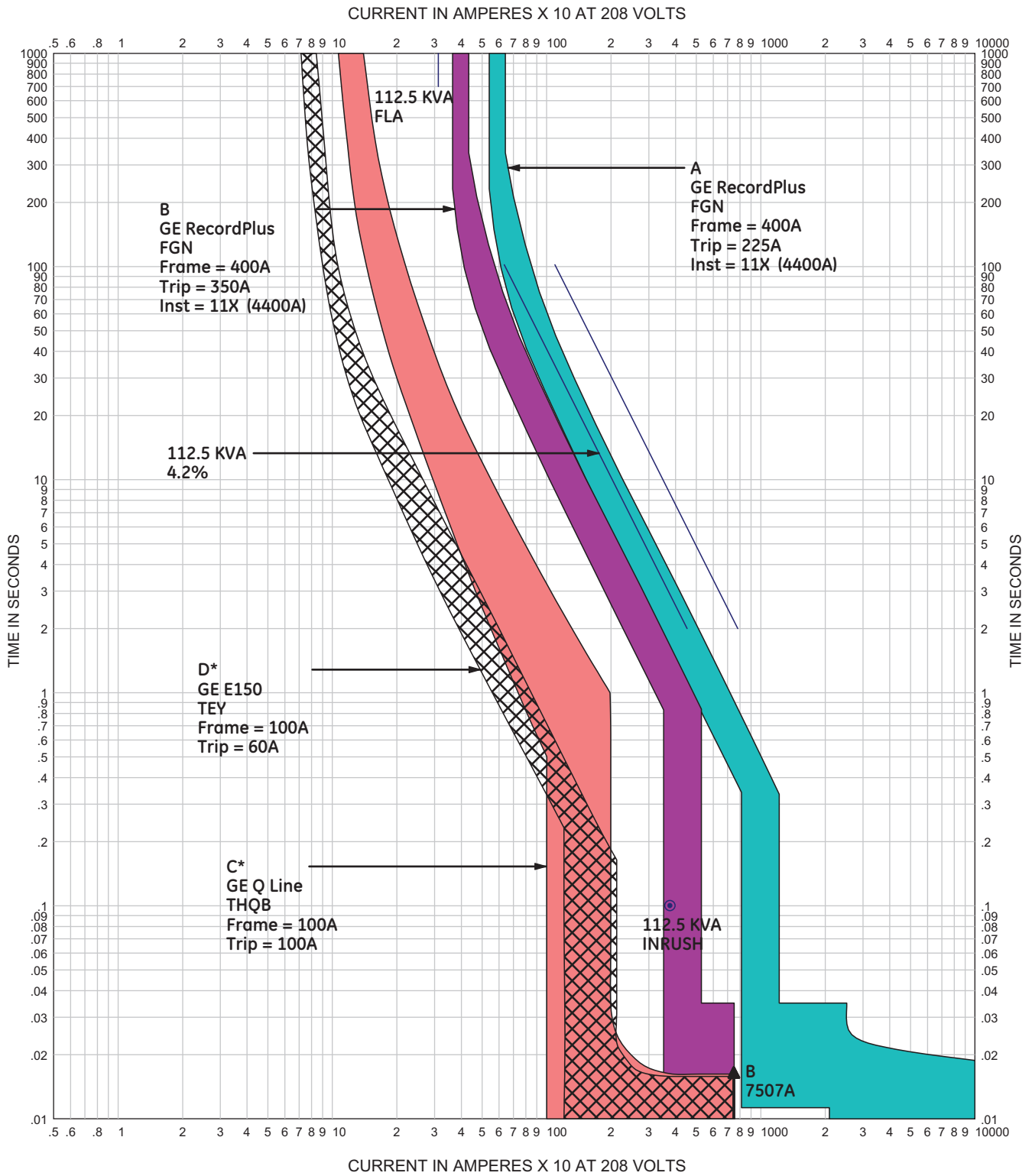

Time-current Curve

Fully Selective Solution for 112.5 kVA Transformer

The following parameters are the basis of the above selective coordination plot:

Minimum allowable Z% = 4.2%

65 kA (X/R=4.9) @ 480V; 7.5 kA @ 208V

112.5 kVA Transformer Template (with ABB S7 Secondary Main)

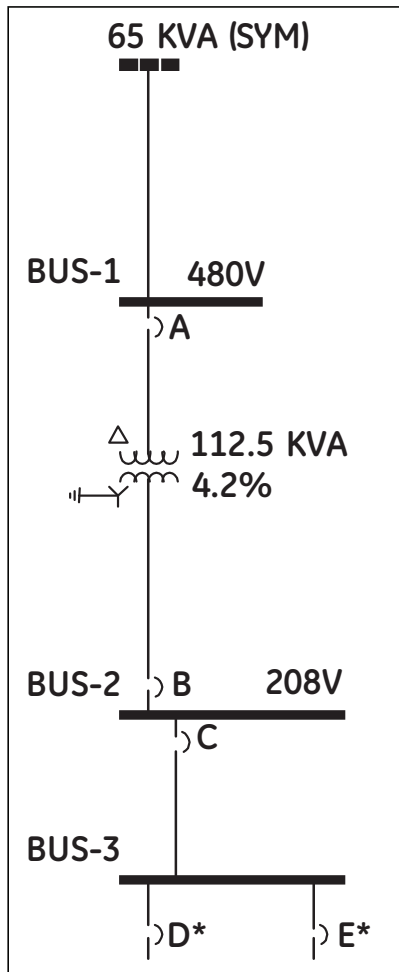

- (A) GE Record Plus MCCB**
 Frame Type: FGN
 Frame Size: 600A
 Sensor: 400A
 Trip: 225A
 IOC Setting: 11X (4400A)
- (B) ABB S7 MCCB**
 Frame Type: ISOMAX
 Frame Size: 1200A
 Sensor: 1000A
 LT Trip: 0.4X (400A)
 LT Delay: A
 ST Trip: 10X (10000A)
 ST Delay: D
 I²t: Out
 IOC Setting: 12X (12000A)
- (C) GE Record Plus MCCB**
 Frame Type: FGN
 Frame Size: 600A
 Sensor: 250A
 Trip: 225A
 IOC Setting: 11X (2750A)
- (D)* GE Q-Line MCCB**
 Frame Type: THQB
 Frame Size: 100A
 Trip: 100A
- (E)* GE TEY MCCB**
 Frame Type: TEY
 Frame Size: 100A
 Trip: 60A

Notes:

Where an overlap of the time-current curve, instantaneous overcurrent characteristics seem to indicate non-selectivity, GE Overcurrent Instantaneous Selectivity Tables, DET-537, were used to validate selective operation.

Unless otherwise noted, overcurrent protective devices shown are for all available pole configurations.

GE typical transformer impedance: 150°C rise, aluminum winding, Z = 5.9%
 This Z% is equal to or greater than the minimum allowed on this coordination plot

* Base layer circuit breaker settings are "not to exceed" values

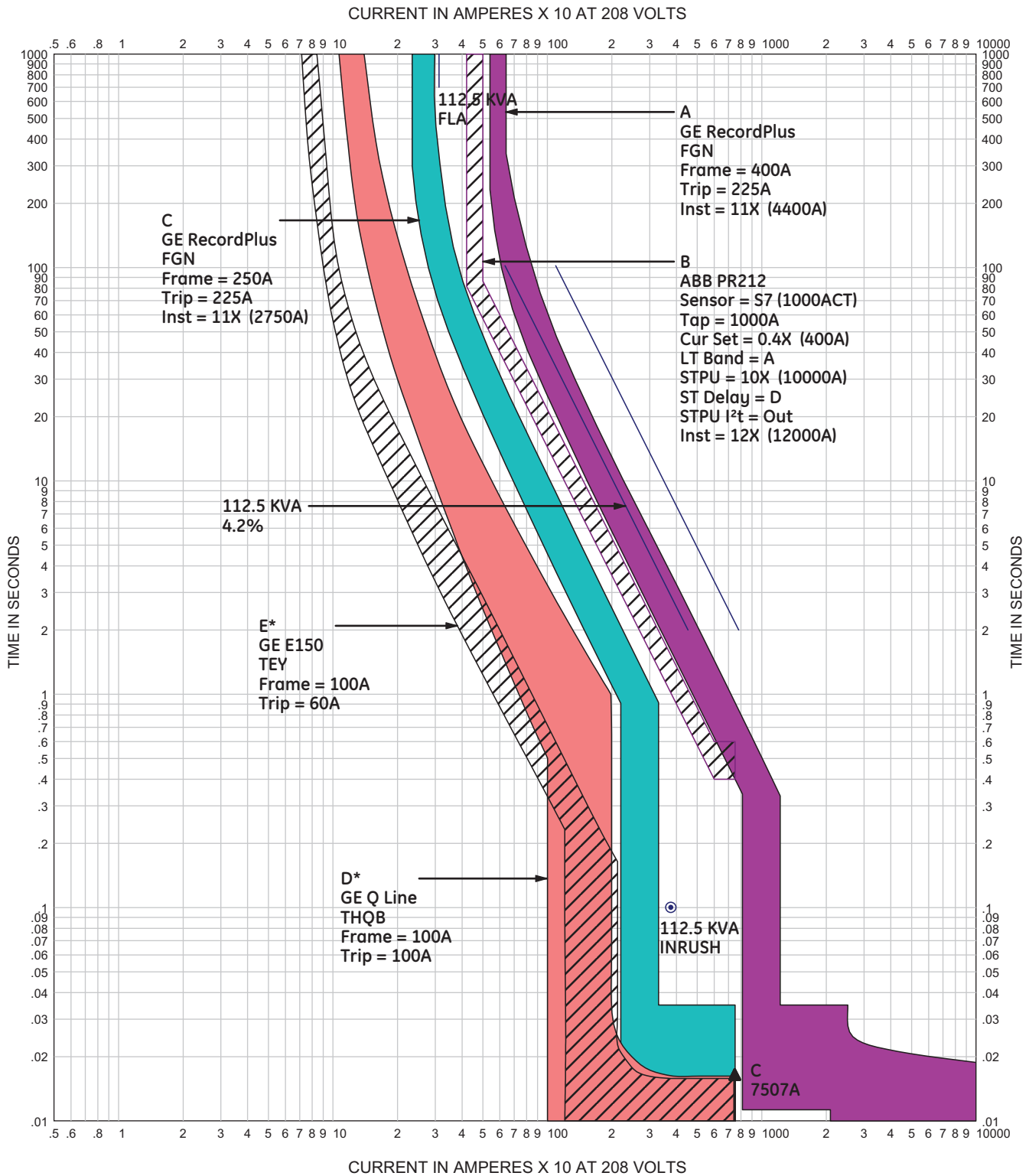

Time-current Curve

Fully Selective Solution for 112.5 kVA Transformer

The following parameters are the basis of the above selective coordination plot:

Minimum allowable Z% = 4.2%

65 kA (X/R=4.9) @ 480V; 7.5 kA @ 208V

150 kVA Transformer Template
(with Record Plus Type FG Primary Main)

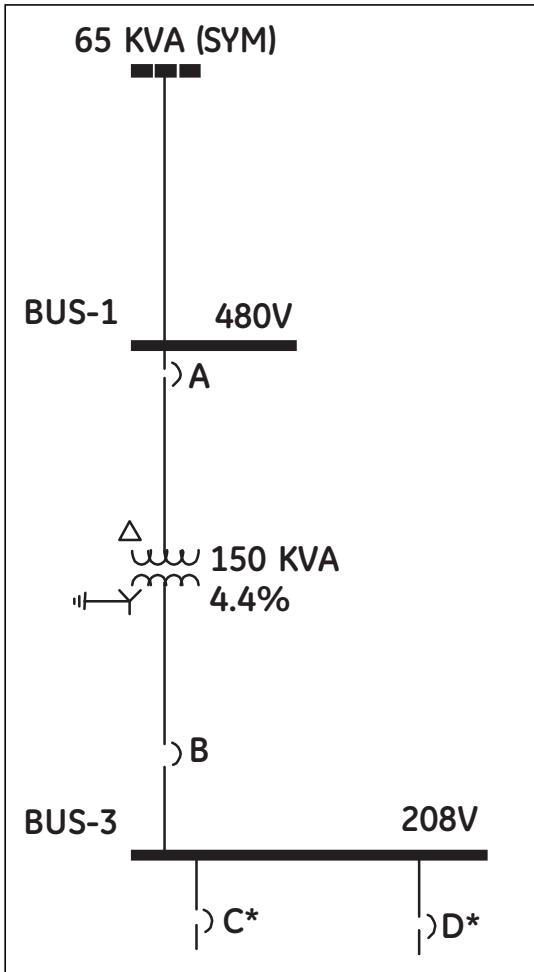

- (A) GE Record Plus MCCB**
 Frame Type: FBN
 Frame Size: 600A
 Sensor: 400A
 Trip: 250A
 IOC Setting: 11X (4400A)
- (B) GE Record Plus MCCB**
 Frame Type: FGN
 Frame Size: 600A
 Sensor: 600A
 Rating Plug: 450A
 IOC Setting: 11X (6600A)
- (C)* GE Q-Line MCCB**
 Frame Type: THQ
 Frame Size: 100A
 Trip: 100A
- (D)* GE Q-Line MCCB**
 Frame Type: THQB Model C
 Frame Size: 100A – 1, 2P
 Trip: 60A

Notes:

Where an overlap of the time-current curve, instantaneous overcurrent characteristics seem to indicate non-selectivity, GE Overcurrent Instantaneous Selectivity Tables, DET-537, were used to validate selective operation.

Unless otherwise noted, overcurrent protective devices shown are for all available pole configurations.

GE typical transformer impedance: 150°C rise, aluminum winding, Z = 4.4%
 This Z% is equal to or greater than the minimum allowed on this coordination plot

* Base layer circuit breaker settings are “not to exceed” values

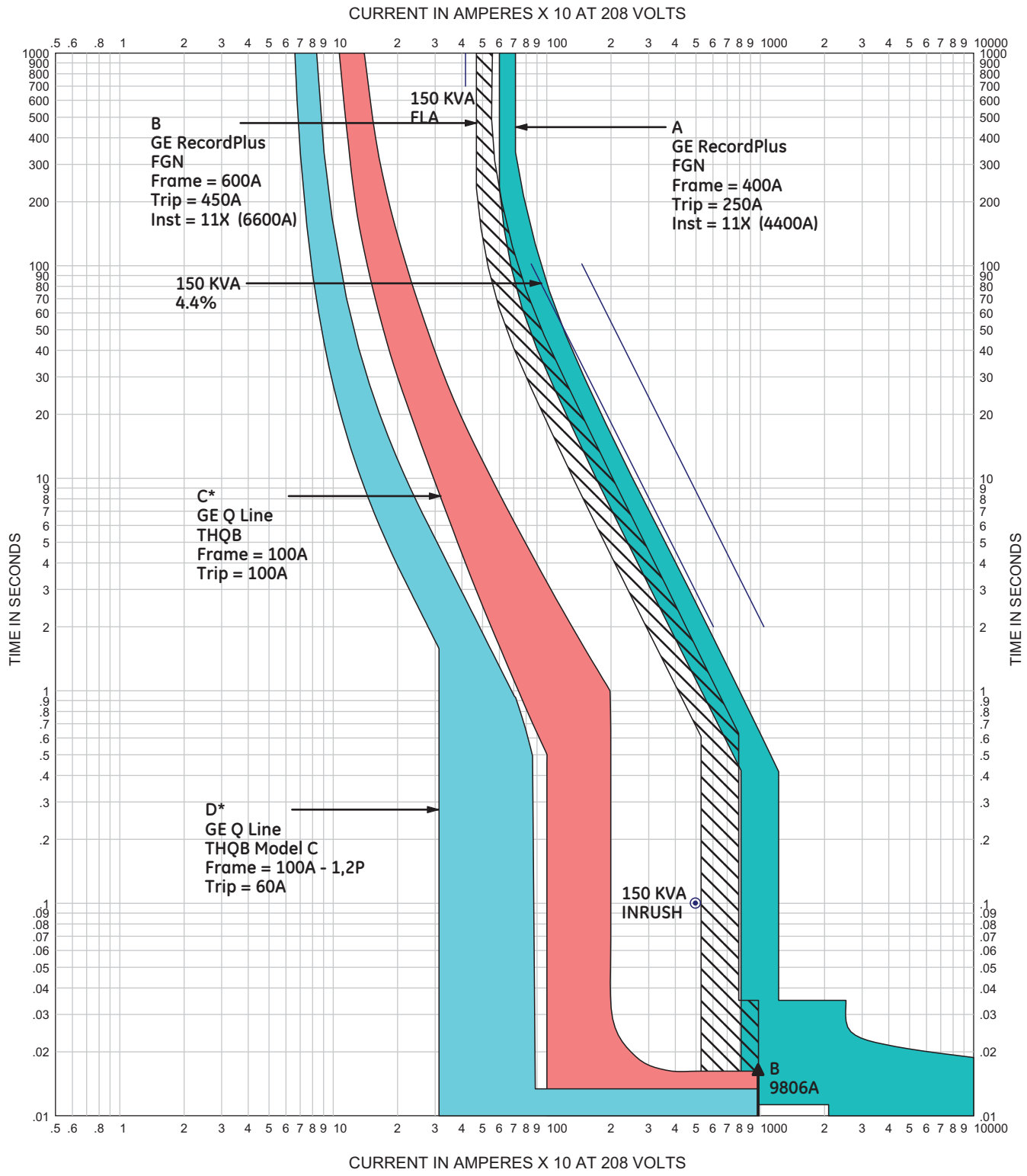

Time-current Curve

Fully Selective Solution for 150 kVA Transformer

The following parameters are the basis of the above selective coordination plot:

Minimum allowable Z% = 4.4%

65 kA (X/R=4.9) @ 480V; 9.8 kA @ 208V

150 kVA Transformer Template (with ABB S7 Primary Main)

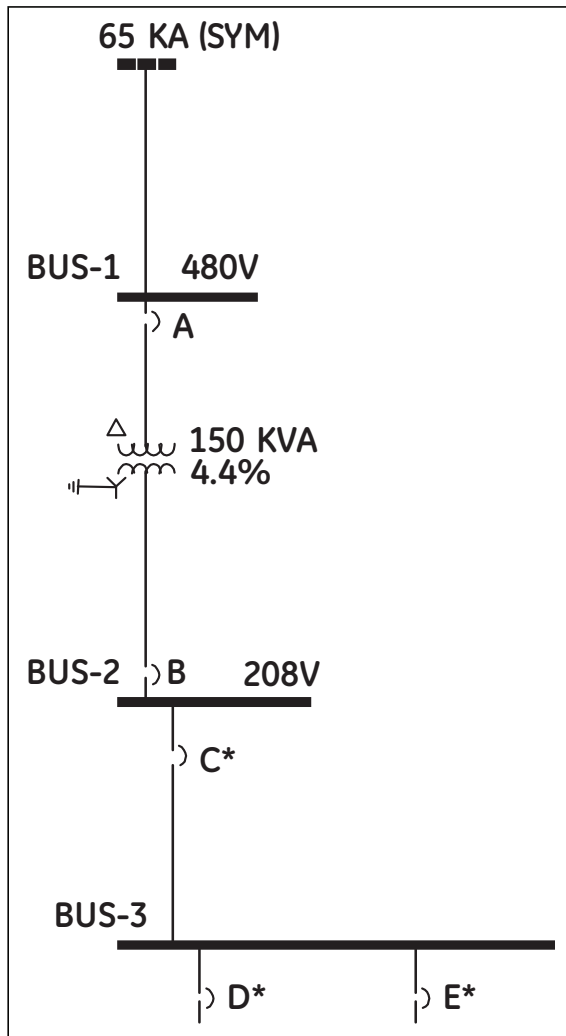

(A) ABB S7 MCCB
 Frame Type: ISOMAX
 Frame Size: 1200A
 Sensor: 1000A
 LT Trip: 0.4X (400A)
 LT Delay: A
 ST Trip: 8X (80000A)
 ST Delay: D
 I²t: Out
 IOC Setting: 12X (12000A)

(B) ABB S7 MCCB
 Frame Type: ISOMAX
 Frame Size: 1200A
 Sensor: 1200A
 LT Trip: 0.4X (480A)
 LT Delay: B
 ST Trip: 8X (9600A)
 ST Delay: C
 I²t: Out
 IOC Setting: 12X (14400A)

(C) GE Record Plus MCCB
 Frame Type: FGN
 Frame Size: 600A
 Sensor: 400A
 Trip: 350A
 IOC Setting: 11X (4400A)

(D)* GE Q-Line MCCB
 Frame Type: THQB
 Frame Size: 100A
 Trip: 100A

(E)* GE TEY MCCB
 Frame Type: TEY
 Frame Size: 100A
 Trip: 60A

Notes:

Where an overlap of the time-current curve, instantaneous overcurrent characteristics seem to indicate non-selectivity, GE Overcurrent Instantaneous Selectivity Tables, DET-537, were used to validate selective operation.

Unless otherwise noted, overcurrent protective devices shown are for all available pole configurations.

GE typical transformer impedance: 150°C rise, aluminum winding, Z = 4.4%
 This Z% is equal to or greater than the minimum allowed on this coordination plot

* Base layer circuit breaker settings are "not to exceed" values

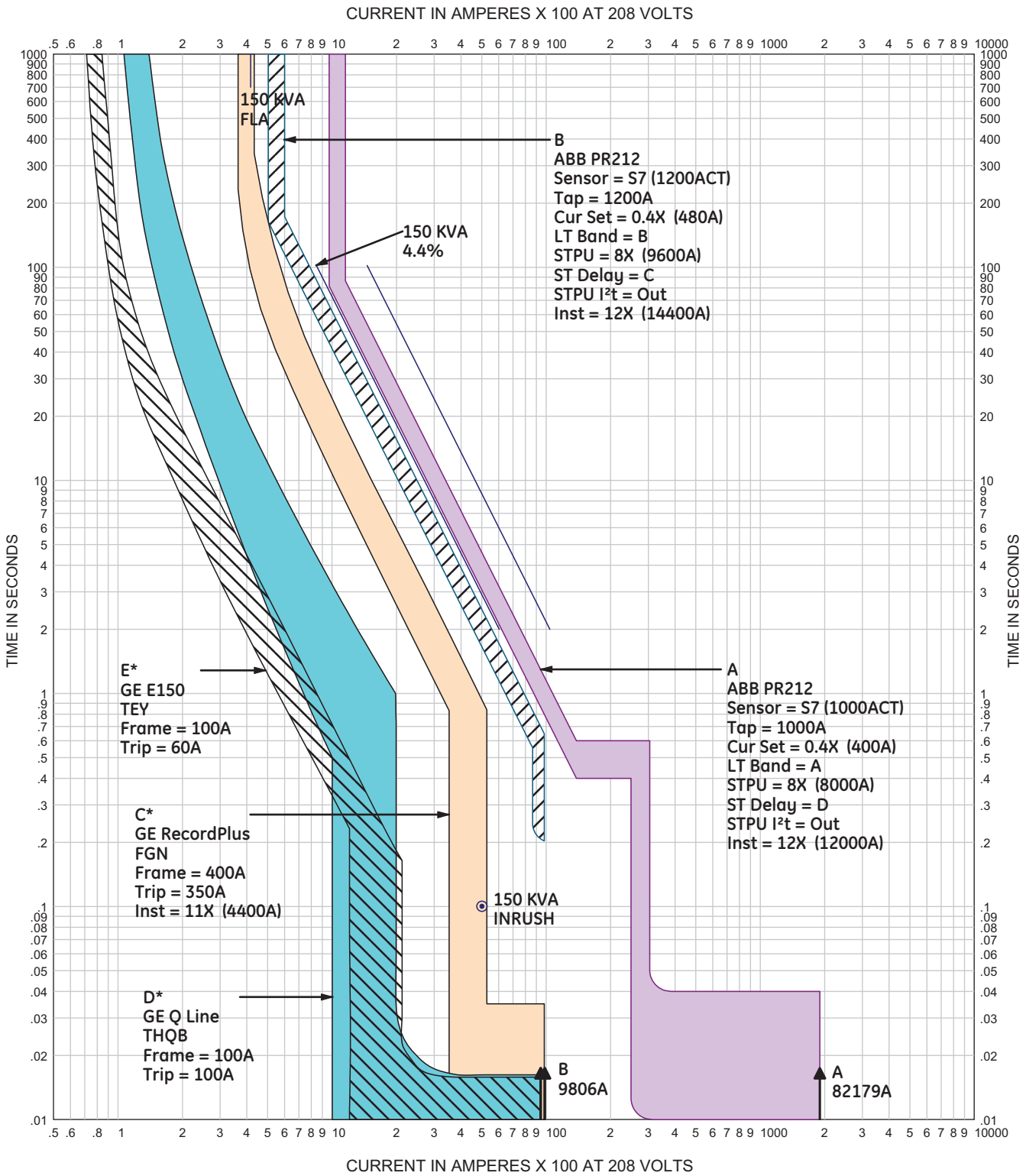

Time-current Curve Fully Selective Solution for 150 kVA Transformer

The following parameters are the basis of the above selective coordination plot:
 Minimum allowable Z% = 4.4%
 65 kA (X/R=4.9) @ 480V; 9.8 kA @ 208V

225 kVA Transformer Template (with ABB S7 Secondary Main)

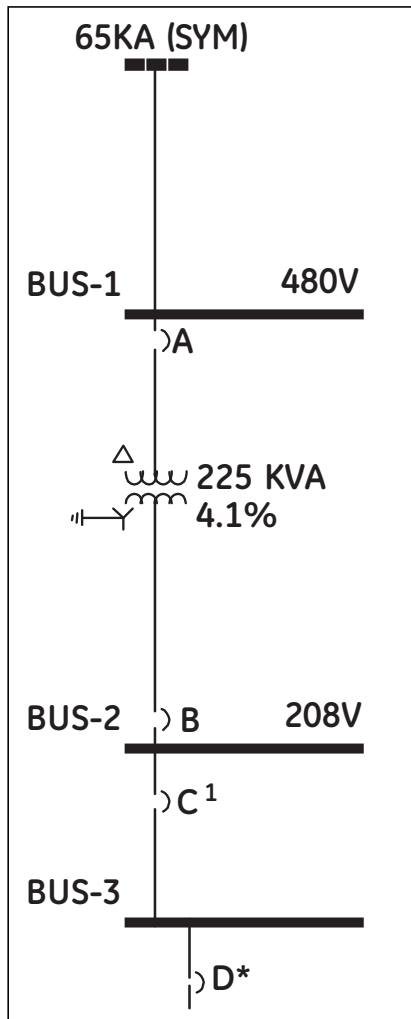

- (A) GE Record Plus MCCB**
 Frame Type: FGN
 Frame Size: 600A
 Sensor: 600A
 Rating Plug: 450A
 IOC Setting: 11X (6600A)
- (B) ABB ISOMAX MCCB**
 Frame Type: S7
 Frame Size: 1200A
 Sensor: 1000A
 LT Setting: 0.7X (700A)
 LT Delay: B
 ST Setting: 10X (10000A)
 ST Delay: D
 I²t: Out
 IOC Setting: 12X (12000A)
- (C)¹ GE Record Plus MCCB**
 Frame Type: FGN
 Frame Size: 600A
 Sensor: 600A
 Rating Plug: 400A
 IOC Setting: 11X (6600A)
- (D)* GE Q-Line MCCB**
 Frame Type: THQB
 Frame Size: 100A
 Trip: 100A

Notes:

Where an overlap of the time-current curve, instantaneous overcurrent characteristics seem to indicate non-selectivity, GE Overcurrent Instantaneous Selectivity Tables, DET-537, were used to validate selective operation.

Unless otherwise noted, overcurrent protective devices shown are for all available pole configurations.

GE typical transformer impedance: 150°C rise, aluminum winding, Z = 7.0%
 This Z% is equal to or greater than the minimum allowed on this coordination plot

* Base layer circuit breaker settings are "not to exceed" values

¹ FG400 and FG600 are selective with all THQB MCCBs. Certain THQBs not selective with FG250 MCCBs.

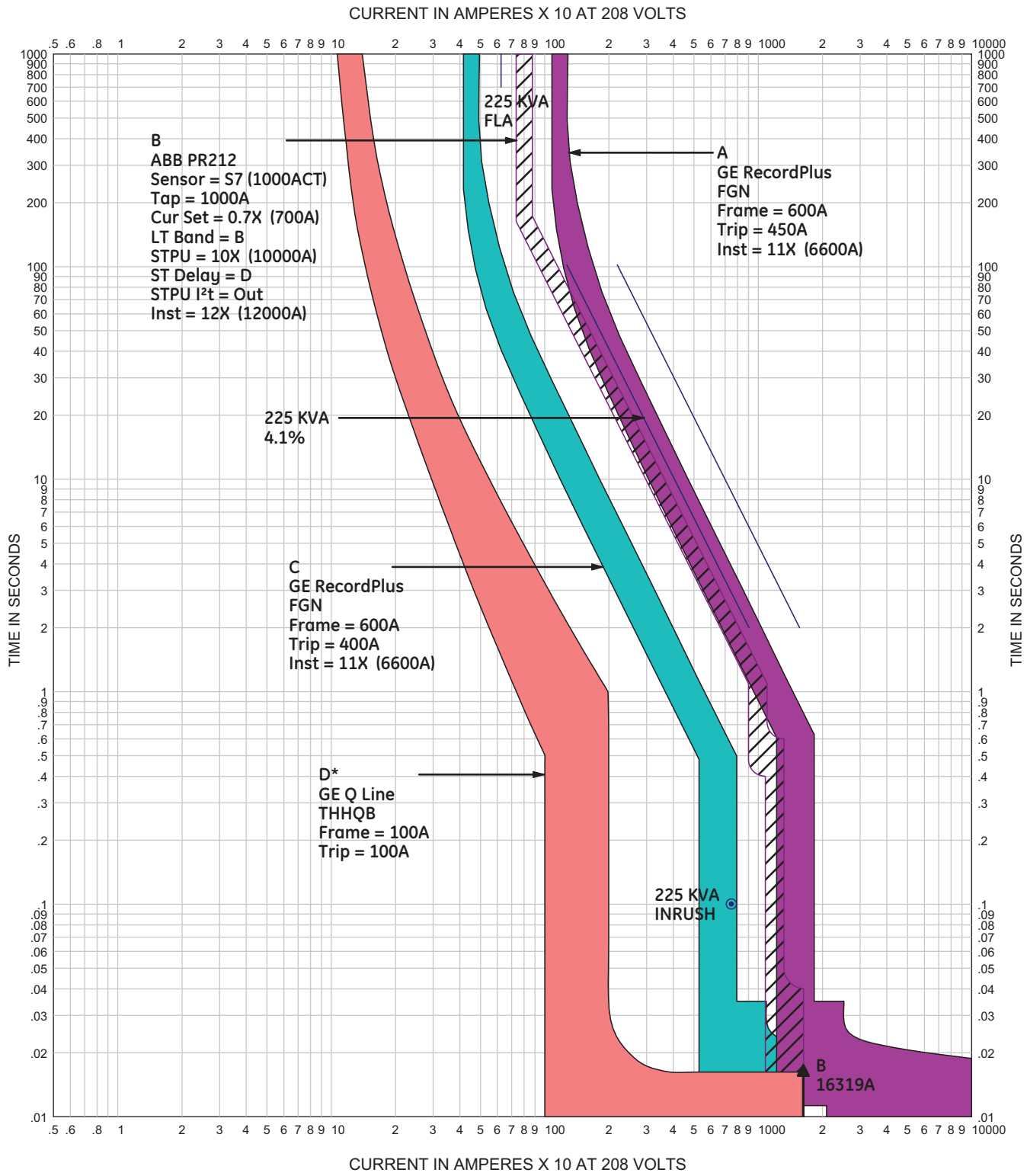

Time-current Curve

Fully Selective Solution for 225 kVA Transformer

The following parameters are the basis of the above selective coordination plot:

Minimum allowable Z% = 4.1%

65 kA (X/R=4.9) @ 480V; 16.3 kA @ 208V

300 kVA Transformer Template (with ABB S7 Secondary Main)

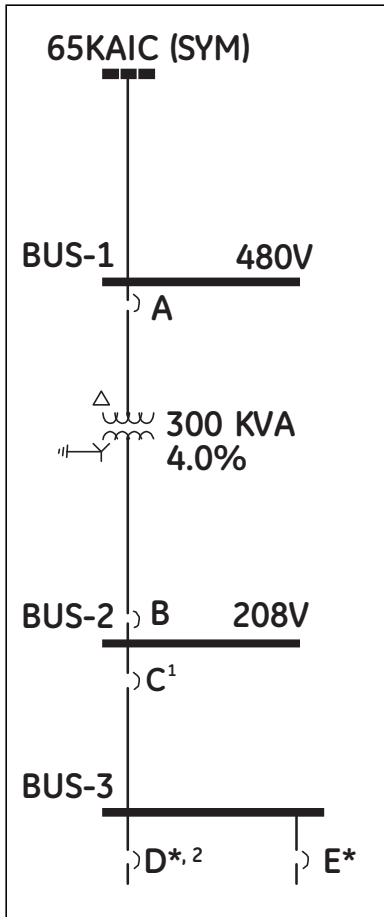

(A) ABB ISOMAX MCCB
 Frame Type: S7
 Frame Size: 1200A
 Sensor: 1000A
 LT Setting: 0.5X (500A)
 LT Delay: B
 ST Setting: 10X (10000A)
 ST Delay: D
 I²t: Out
 IOC Setting: 12X (12000A)

(B) ABB ISOMAX MCCB
 Frame Type: S7
 Frame Size: 1200A
 Sensor: 1000A
 LT Setting: 1.0X (1000A)
 LT Delay: A
 ST Setting: 10X (1000A)
 ST Delay: D
 I²t: Out
 IOC Setting: 12X (12000A)

(C)¹ GE Record Plus MCCB
 Frame Type: FGN
 Frame Size: 600A
 Sensor: 600A
 Rating Plug: 500A
 IOC Setting: 11X (6600A)

(D)^{*2} GE Q-Line MCCB
 Frame Type: THHQB
 Frame Size: 100A
 Trip: 100A

(E)^{*} GE Record Plus MCCB
 Frame Type: FBN
 Frame Size: 100A
 Trip: 100A

Notes:

Where an overlap of the time-current curve, instantaneous overcurrent characteristics seem to indicate non-selectivity, GE Overcurrent Instantaneous Selectivity Tables, DET-537, were used to validate selective operation.

Unless otherwise noted, overcurrent protective devices shown are for all available pole configurations.

GE typical transformer impedance: 150°C rise, aluminum winding, Z = 7.4%
 This Z% is equal to or greater than the minimum allowed on this coordination plot

* Base layer circuit breaker settings are "not to exceed" values

¹ FG400 and FG600 are selective with all THQB MCCBs. Certain THHQB not selective with FG250 MCCBs.

² THHQB can only be used if AIC is less than 22 kA at the THHQB MCCB

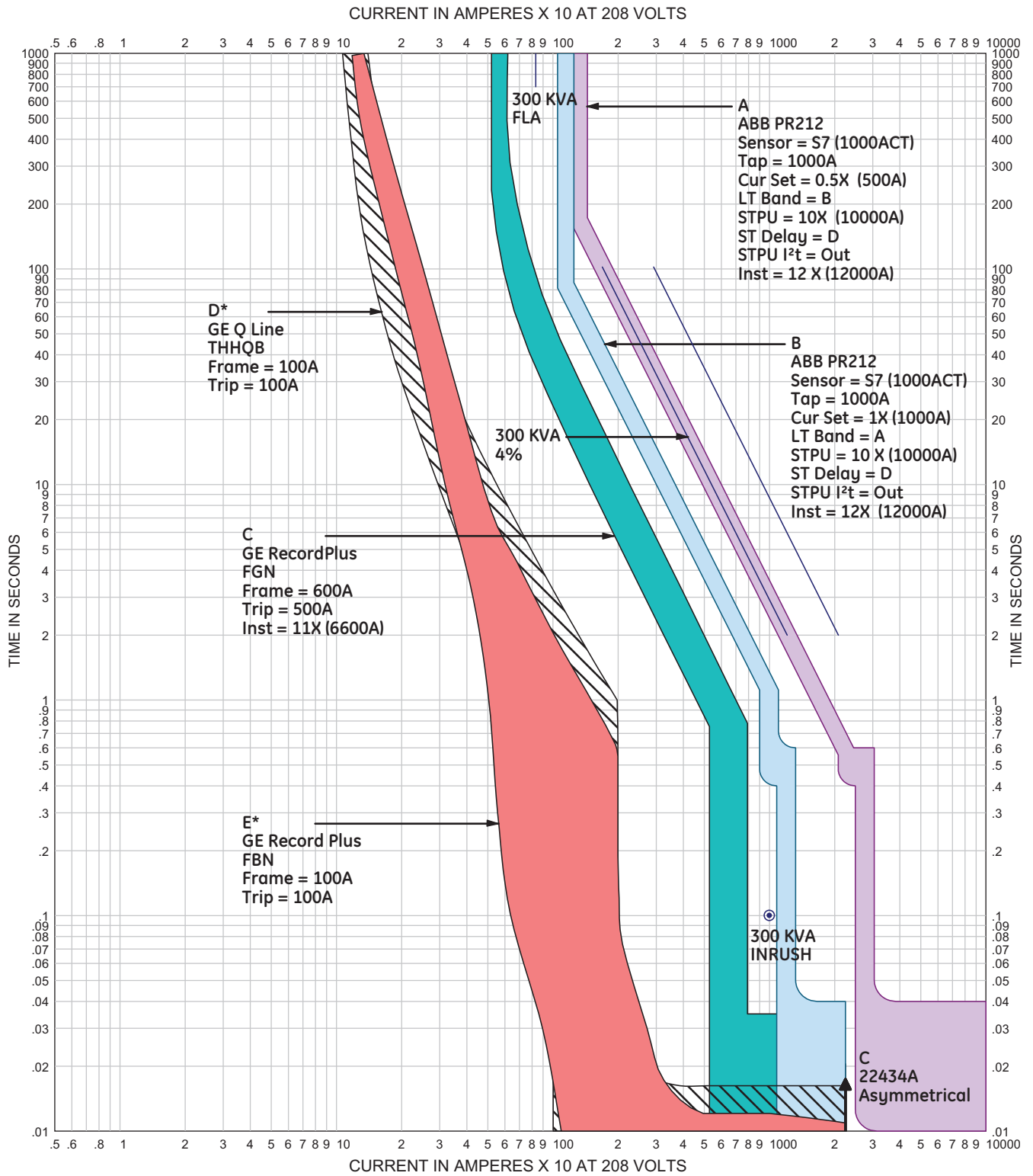

Time-current Curve

Fully Selective Solution for 300 kVA Transformer

The following parameters are the basis of the above selective coordination plot:
 Minimum allowable Z% = 4.0%
 65 kA (X/R=4.9) @ 480V; 22.4 kA @ 208V

Typical GE Dry Type Transformer Data

Table 3

480V Delta to 208/120V Wye, TP-1 Transformers

kVA	°C Rise	Aluminum					Copper				
		Cat. No.	%R	%X	%Z	X/R	Cat. No.	%R	%X	%Z	X/R
15	150	9T83B3871	5.1	3.3	6.1	0.6	9T83C9871	4.3	2.2	4.8	0.5
	115	9T83B3871G15	5.1	3.3	6.1	0.6	9T83C9871G15	4.3	2.2	4.8	0.5
	80	9T83B3871G80	5.1	3.3	6.1	0.6	9T83C9871G80	1.3	2.1	2.5	1.6
30	150	9T83B3872	3.7	4.2	5.6	1.1	9T83C9872	2.8	4.3	5.1	1.8
	115	9T83B3872G15	3.7	4.2	5.6	1.1	9T83C9872G15	2.8	4.3	5.1	1.8
	80	9T83B3872G80	2.1	2.7	3.4	1.3	9T83C9872G80	1.9	2.3	3	1.2
45	150	9T83B3873	3.5	4.1	5.4	1.2	9T83C9873	3	3.5	4.6	1.2
	115	9T83B3873G15	3.5	4.1	5.4	1.2	9T83C9873G15	3	3.5	4.6	1.2
	80	9T83B3873G80	1.3	3.1	3.4	2.4	9T83C9873G80	1	2.5	2.7	2.5
75	150	9T83B3874	3.9	4.5	6.0	1.2	9T83C9874	3.4	4	5.2	1.2
	115	9T83B3874G15	2.8	4.7	5.5	1.7	9T83C9874G15	2.7	3.5	4.4	1.3
	80	9T83B3874G80	1.1	3.5	3.7	3.2	9T83C9874G80	1	2.6	2.8	2.6
112.5	150	9T83B3875	3.1	5.0	5.9	1.6	9T83C9875	2.7	3.8	4.6	1.4
	115	9T83B3875G15	2.3	4.1	4.7	1.0	9T83C9875G15	2.5	4.8	5.4	1.9
	80	9T40G0005G81	1.8	2.2	2.8	1.2	9T45G0005G81	1.5	1.9	2.4	1.3
150	150	9T40G0006	2.4	3.7	4.4	1.5	9T45G0006	2	3.1	3.7	1.6
	115	9T40G0006G51	2.4	3.7	4.4	1.5	9T45G0006G51	2	3.1	3.7	1.6
	80	9T40G0006G81	2.4	3.7	4.4	1.5	9T45G0006G81	2	3.1	3.7	1.6
225	150	9T40G0007	4.3	5.6	7.0	1.3	9T45G0007	3.7	4.6	5.9	1.2
	115	9T40G0007G51	2.4	5.0	5.5	1.9	9T45G0007G51	2	3.8	4.3	1.9
	80	9T40G0007G81	2.6	4.9	5.6	1.9	9T45G0007G81	2	3.8	4.3	1.9
300	150	9T40G0008	4.0	6.2	7.4	1.6	9T45G0008	3.3	4.6	5.7	1.4
	115	9T40G0008G51	1.8	5.2	5.5	2.9	9T45G0008G51	1.6	3.2	3.5	2.0

Glossary

Abbreviations

AHJ	Authority having jurisdiction
AIC	Amperes interrupting current
ATS	Automatic transfer switch
FTL	Feed through lugs
ICCB	Insulated case circuit breaker (UL Standard 489 rated)
IOC	Instantaneous overcurrent
kA	Kilo-amperes
LVPCB	Low Voltage Power Circuit Breaker (ANSI Standard C37. rated)
MCCB	Molded Case Circuit Breaker (UL Standard 489 rated)
MCS	Molded Case Switch
NEC	National Electric Code
OCPD	Overcurrent Protective Device
V	Volts
xfmr	Transformer

Terms As Used in This Publication

0.1 second selectivity

Two adjacent OCPDs are selective with one another over the full range of AIC, but only down to 0.1 seconds on the TCC. This suggests that their long time and short time characteristics are selective with one another, but that their instantaneous characteristics (that portion of the TCC below 0.1 seconds) may not be selective

Code

National Electrical Code

Downstream / Upstream

A circuit breaker's or OCPDs location relative to the power source. For example, a main circuit breaker in a panel is closer to the power source than a (smaller sized) branch breaker in the same panel is upstream of the branch breaker. Correspondingly, the branch breaker is downstream of the main breaker in this example.

Full Selectivity

In the context of NEC Articles 700, 701 and 708, this means two adjacent OCPDs are selective with one another over the full range of available fault current magnitudes and for all types of fault current.

Layer

On a one-line diagram, circuit breaker or OCPD layers are counted from a load back to a power source. Each circuit breaker placed above another on the circuit back to the source is another layer.

GE
41 Woodford Avenue, Plainville, CT 06062
www.geelectrical.com
© 2010 General Electric Company

